

# Metallized Polyester Film Capacitors

## FDJ Series - 63 ~ 1000VDC (Automotive Grade DC Film Capacitor)



### Overview

The FDJ capacitor is constructed of metallized polyester film encapsulated with epoxy resin in a plastic box, with 2 or 4 tinned copper wire. These FDJ series has maximum operating temperature of 125°C and qualify in accordance to AEC-Q200D requirement.

### Applications

Widely used in low voltage DC Link circuit, DC filtering and automotive applications.

### Features

- Self-healing
- Segmented film design
- Capacitance up to 560μF
- High temperature capability up to 125°C.
- High contact reliability
- Automotive Grade (AEC-Q200D)

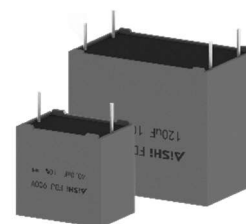

### Qualification

Reference Standard	IEC 60384-2, AEC-Q200D
Climate Category	55/125/56 IEC 60068-1



### Marking

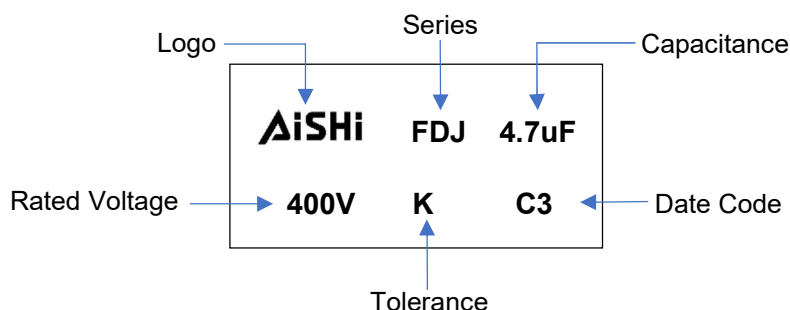

### Manufacturing Date Code

Year	Code	Month	Code
2018	A	Jan	1
2019	B	Feb	2
2020	C	Mar	3
2021	D	Apr	4
2022	E	May	5
2023	F	Jun	6

Year	Code	Month	Code
2024	G	Jul	7
2025	H	Aug	8
2026	J	Sep	9
2027	K	Oct	A
2028	L	Nov	N
2029	M	Dec	D

**Part Number System**

<b>F</b>	<b>DJ</b>	<b>2G</b>	<b>K</b>	<b>475</b>	<b>G33</b>	<b>2GL</b>	<b>5</b>
Capacitor Type	Series	Voltage (VDC)	Tolerance	Capacitance (pF)	Size Code	Terminal Code	Lead Length Code
F = Film	DC Link, AEC-Q200 Type, Metallized PE Film	63=1J 100=1K 160=2C 250=2E 400=2G 630=2L 1000=3K	J = ±5% K = ±10% M = ±20%	First two digits = significant figures. Third digit = Number of zeros.	Refer to Size Code Table	Refer to Terminal Code Table	Refer to Lead Length Code Table

**Terminal Code**

Digit One (Lead/Terminal Type)		Digit Two (Lead Space)		Digit Three (Lead Ipsilateral)	
2 leads for long	L	10.0mm	C	5.1mm	A
2 leads for straight cut	2	12.5mm	D	7.5mm	C
2 leads for forming cut	E	15.0mm	E	10.2mm	B
4 leads for straight cut	4	22.5mm	F	12.7mm	G
6 leads for straight cut	6	27.5mm	G	20.3mm	D
		37.5mm	K	N/A	L
		57.5mm	M		
		N/A	N		

**Lead Length Code**

Lead Length	
20mm min	L
35mm min	B
3.2mm	1
3.5mm	2
3.0mm	3
4.0mm	4
5.0mm	5
7.0mm	7
Taping	T
N/A	N

# Metallized Polyester Film Capacitors

## FDJ Series - 63 ~ 1000VDC (Automotive Grade DC Film Capacitor)

### Dimension (mm)

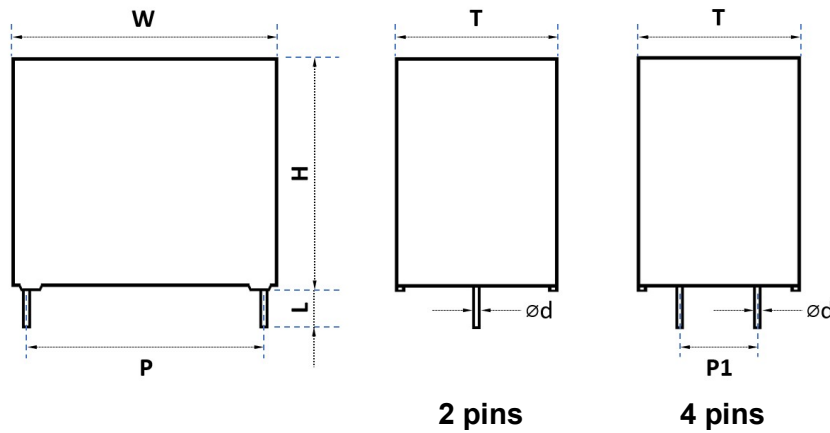

### Size Code Table (mm)

Size Code	Dimension						Pitch				Lead Wire	
	W	Tolerance	H	Tolerance	T	Tolerance	P	Tolerance	P1	Tolerance	Ød	Tolerance
C13	13.0	0.5	11.0	0.5	5.0	0.5	10.0	0.5	\	\	0.6	0.05
C16	13.0	0.5	12.0	0.5	6.0	0.5	10.0	0.5	\	\	0.6	0.05
C30	13.0	0.5	16.0	0.5	9.0	0.5	10.0	0.5	\	\	0.6	0.05
E14	18.0	0.5	11.0	0.5	5.0	0.5	10.0	0.5	\	\	0.6	0.05
E21	18.0	0.5	13.0	0.5	7.0	0.5	15.0	0.5	\	\	0.8	0.05
E29	18.0	0.5	13.5	0.5	7.5	0.5	15.0	0.5	\	\	0.8	0.05
E34	18.0	0.5	14.5	0.5	8.5	0.5	15.0	0.5	\	\	0.8	0.05
E39	18.0	0.5	18.0	0.5	9.0	0.5	15.0	0.5	\	\	0.8	0.05
E45	18.0	0.5	18.0	0.5	10.0	0.5	15.0	0.5	\	\	0.8	0.05
F15	26.0	0.8	14.0	0.8	7.0	0.8	22.5	0.5	\	\	0.8	0.05
F20	26.0	0.8	17.0	0.8	8.5	0.8	22.5	0.5	\	\	0.8	0.05
F24	26.0	0.8	19.0	0.8	10.0	0.8	22.5	0.5	\	\	0.8	0.05
F26	26.0	0.8	20.0	0.8	11.0	0.8	22.5	0.5	\	\	0.8	0.05
F27	26.0	0.8	22.0	0.8	12.0	0.8	22.5	0.5	\	\	0.8	0.05
G15	32.0	0.8	18.0	0.8	9.0	0.8	27.5	0.5	\	\	0.8	0.05
G18	32.0	0.8	20.0	0.8	11.0	0.8	27.5	0.5	\	\	0.8	0.05
G21	32.0	0.8	22.0	0.8	13.0	0.8	27.5	0.5	\	\	0.8	0.05
G22	32.0	0.8	24.5	0.8	13.0	0.8	27.5	0.5	\	\	0.8	0.05
G27	32.0	0.8	24.5	0.8	15.0	0.8	27.5	0.5	\	\	0.8	0.05
G33	32.0	0.8	28.0	0.8	18.0	0.8	27.5	0.5	\	\	0.8	0.05
G37	32.0	0.8	31.0	0.8	21.0	0.8	27.5	0.5	\	\	0.8	0.05
G56	32.0	0.8	31.0	0.8	31.0	0.8	27.5	0.5	\	\	0.8	0.05
G57	32.0	0.8	35.0	0.8	20.0	0.8	27.5	0.5	\	\	0.8	0.05
K22	42.5	0.8	36.0	0.8	19.0	0.8	37.5	0.5	10.2	0.5	1.2	0.05
K24	42.5	0.8	40.0	0.8	20.0	0.8	37.5	0.5	10.2	0.5	1.2	0.05
K32	42.5	0.8	44.0	0.8	24.0	0.8	37.5	0.5	10.2	0.5	1.2	0.05
K42	42.5	0.8	45.0	0.8	30.0	0.8	37.5	0.5	20.3	0.5	1.2	0.05
M10	57.5	1.0	45.0	1.0	25.0	1.0	52.5	0.5	10.2	0.5	1.2	0.05
M16	57.5	1.0	45.0	1.0	30.0	1.0	52.5	0.5	20.3	0.5	1.2	0.05
M20	57.5	1.0	50.0	1.0	35.0	1.0	52.5	0.5	20.3	0.5	1.2	0.05

# Metallized Polyester Film Capacitors

## FDJ Series - 63 ~ 1000VDC (Automotive Grade DC Film Capacitor)



### Rating and Part Number

Vdc	Vac	Cap Value μF	Dimensions					Peak Current A	Surge Current A	dv/dt V/us	Lead Wire mm	Part Number
			W mm	H mm	T mm	P mm	P1 mm					
63	50	1.5	13.0	11.0	5.0	10.0	\	18.0	54.0	12	0.6	FDJ1JK155C132CL5
63	50	2.2	13.0	12.0	6.0	10.0	\	26.4	79.2	12	0.6	FDJ1JK225C162CL5
63	50	3.3	13.0	16.0	9.0	10.0	\	39.6	118.8	12	0.6	FDJ1JK335C302CL5
63	50	3.3	18.0	13.0	7.0	15.0	\	26.4	79.2	8	0.8	FDJ1JK335E212EL5
63	50	4.7	13.0	16.0	9.0	10.0	\	56.4	169.2	12	0.6	FDJ1JK475C302CL5
63	50	4.7	18.0	13.5	7.5	15.0	\	37.6	112.8	8	0.8	FDJ1JK475E292EL5
63	50	6.8	18.0	14.5	8.5	15.0	\	54.4	163.2	8	0.8	FDJ1JK685E342EL5
63	50	10	18.0	18.0	9.0	15.0	\	80.0	240.0	8	0.8	FDJ1JK106E392EL5
63	50	15	26.0	17.0	8.5	22.5	\	75.0	225.0	5	0.8	FDJ1JK156F202FL5
63	50	22	26.0	19.0	10.0	22.5	\	110.0	330.0	5	0.8	FDJ1JK226F242FL5
63	50	18	32.0	18.0	9.0	27.5	\	54.0	162.0	3	0.8	FDJ1JK186G152GL5
63	50	22	32.0	20.0	11.0	27.5	\	66.0	198.0	3	0.8	FDJ1JK226G182GL5
63	50	27	32.0	20.0	11.0	27.5	\	81.0	243.0	3	0.8	FDJ1JK276G182GL5
63	50	33	32.0	22.0	13.0	27.5	\	99.0	297.0	3	0.8	FDJ1JK336G212GL5
63	50	39	32.0	22.0	13.0	27.5	\	117.0	351.0	3	0.8	FDJ1JK396G212GL5
63	50	47	32.0	24.5	15.0	27.5	\	141.0	423.0	3	0.8	FDJ1JK476G272GL5
63	50	56	32.0	28.0	18.0	27.5	\	168.0	504.0	3	0.8	FDJ1JK566G332GL5
63	50	68	32.0	28.0	18.0	27.5	\	204.0	612.0	3	0.8	FDJ1JK686G332GL5
63	50	82	32.0	31.0	21.0	27.5	\	246.0	738.0	3	0.8	FDJ1JK826G372GL5
63	50	100	32.0	31.0	21.0	27.5	\	300.0	900.0	3	0.8	FDJ1JK107G372GL5
63	50	100	42.5	36.0	19.0	37.5	10.2	80.0	240.0	1	1.2	FDJ1JK107K224KB5
63	50	120	42.5	36.0	19.0	37.5	10.2	96.0	288.0	1	1.2	FDJ1JK127K224KB5
63	50	150	42.5	36.0	19.0	37.5	10.2	120.0	360.0	1	1.2	FDJ1JK157K224KB5
63	50	180	42.5	40.0	20.0	37.5	10.2	144.0	432.0	1	1.2	FDJ1JK187K244KB5
63	50	220	42.5	44.0	24.0	37.5	10.2	176.0	528.0	1	1.2	FDJ1JK227K324KB5
63	50	270	42.5	45.0	30.0	37.5	20.3	216.0	648.0	1	1.2	FDJ1JK277K424KD5
63	50	330	42.5	45.0	30.0	37.5	20.3	264.0	792.0	1	1.2	FDJ1JK337K424KD5
63	50	220	57.5	45.0	25.0	52.5	10.2	44.0	132.0	0	1.2	FDJ1JK227M104MB5
63	50	270	57.5	45.0	25.0	52.5	10.2	54.0	162.0	0	1.2	FDJ1JK277M104MB5
63	50	330	57.5	45.0	25.0	52.5	10.2	66.0	198.0	0	1.2	FDJ1JK337M104MB5
63	50	390	57.5	45.0	30.0	52.5	20.3	78.0	234.0	0	1.2	FDJ1JK397M164MD5
63	50	470	57.5	50.0	35.0	52.5	20.3	94.0	282.0	0	1.2	FDJ1JK477M204MD5
63	50	560	57.5	50.0	35.0	52.5	20.3	112.0	336.0	0	1.2	FDJ1JK567M204MD5
100	50	1.0	18.0	11.0	5.0	10.0	\	10.0	30.0	10	0.6	FDJ1KK105E142EL5
100	50	1.5	18.0	13.0	7.0	10.0	\	15.0	45.0	10	0.8	FDJ1KK155E212EL5
100	50	2.2	18.0	13.0	7.0	10.0	\	22.0	66.0	10	0.8	FDJ1KK225E212EL5
100	50	3.3	18.0	14.5	8.5	15.0	\	33.0	99.0	10	0.8	FDJ1KK335E342EL5
100	50	4.7	18.0	14.5	8.5	15.0	\	47.0	141.0	10	0.8	FDJ1KK475E342EL5
100	50	4.7	26.0	17.0	8.5	22.5	\	28.2	84.6	6	0.8	FDJ1KK475F202FL5
100	50	6.8	26.0	17.0	8.5	22.5	\	40.8	122.4	6	0.8	FDJ1KK685F202FL5
100	50	10	26.0	19.0	10.0	22.5	\	60.0	180.0	6	0.8	FDJ1KK106F242FL5
100	50	15	26.0	19.0	10.0	22.5	\	90.0	270.0	6	0.8	FDJ1KK156F242FL5
100	50	15	32.0	20.0	11.0	27.5	\	75.0	225.0	5	0.8	FDJ1KK156G182GL5
100	50	18	32.0	22.0	13.0	27.5	\	90.0	270.0	5	0.8	FDJ1KK186G212GL5
100	50	22	32.0	22.0	13.0	27.5	\	110.0	330.0	5	0.8	FDJ1KK226G212GL5
100	50	27	32.0	24.5	15.0	27.5	\	135.0	405.0	5	0.8	FDJ1KK276G272GL5
100	50	33	32.0	28.0	18.0	27.5	\	165.0	495.0	5	0.8	FDJ1KK336G332GL5
100	50	39	32.0	28.0	18.0	27.5	\	195.0	585.0	5	0.8	FDJ1KK396G332GL5

# Metallized Polyester Film Capacitors

## FDJ Series - 63 ~ 1000VDC (Automotive Grade DC Film Capacitor)



### Rating and Part Number

Vdc	Vac	Cap Value μF	Dimensions					Peak Current A	Surge Current A	dv/dt V/us	Lead Wire mm	Part Number
			W mm	H mm	T mm	P mm	P1 mm					
100	50	47	32.0	31.0	21.0	27.5	\	235.0	705.0	5	0.8	FDJ1KK476G372GL5
100	50	56	32.0	31.0	21.0	27.5	\	280.0	840.0	5	0.8	FDJ1KK566G372GL5
100	50	56	42.5	36.0	19.0	37.5	10.2	56.0	168.0	1	1.2	FDJ1KK566K224KB5
100	50	68	42.5	36.0	19.0	37.5	10.2	68.0	204.0	1	1.2	FDJ1KK686K224KB5
100	50	82	42.5	36.0	19.0	37.5	10.2	82.0	246.0	1	1.2	FDJ1KK826K224KB5
100	50	100	42.5	40.0	20.0	37.5	10.2	100.0	300.0	1	1.2	FDJ1KK107K244KB5
100	50	120	42.5	44.0	24.0	37.5	10.2	120.0	360.0	1	1.2	FDJ1KK127K324KB5
100	50	150	42.5	45.0	30.0	37.5	20.3	150.0	450.0	1	1.2	FDJ1KK157K424KD5
100	50	180	42.5	45.0	30.0	37.5	20.3	180.0	540.0	1	1.2	FDJ1KK187K424KD5
100	50	120	57.5	45.0	25.0	52.5	10.2	36.0	108.0	0	1.2	FDJ1KK127M104MB5
100	50	150	57.5	45.0	25.0	52.5	10.2	45.0	135.0	0	1.2	FDJ1KK157M104MB5
100	50	180	57.5	45.0	25.0	52.5	10.2	54.0	162.0	0	1.2	FDJ1KK187M104MB5
100	50	220	57.5	45.0	30.0	52.5	20.3	66.0	198.0	0	1.2	FDJ1KK227M164MD5
100	50	270	57.5	50.0	35.0	52.5	20.3	81.0	243.0	0	1.2	FDJ1KK277M204MD5
100	50	330	57.5	50.0	35.0	52.5	20.3	99.0	297.0	0	1.2	FDJ1KK337M204MD5
160	80	4.7	32.0	18.0	9.0	27.5	\	28.2	84.6	6	0.8	FDJ2CK475G152GL5
160	80	6.8	32.0	20.0	11.0	27.5	\	40.8	122.4	6	0.8	FDJ2CK685G182GL5
160	80	10	32.0	20.0	11.0	27.5	\	60.0	180.0	6	0.8	FDJ2CK106G182GL5
160	80	15	32.0	22.0	13.0	27.5	\	90.0	270.0	6	0.8	FDJ2CK156G212GL5
160	80	18	32.0	24.5	15.0	27.5	\	108.0	324.0	6	0.8	FDJ2CK186G272GL5
160	80	22	32.0	28.0	18.0	27.5	\	132.0	396.0	6	0.8	FDJ2CK226G332GL5
160	80	27	32.0	28.0	18.0	27.5	\	162.0	486.0	6	0.8	FDJ2CK276G332GL5
160	80	33	32.0	31.0	31.0	27.5	\	198.0	594.0	6	0.8	FDJ2CK336G562GL5
160	80	33	42.5	36.0	19.0	37.5	10.2	66.0	198.0	2	1.2	FDJ2CK336K224KB5
160	80	39	42.5	36.0	19.0	37.5	10.2	78.0	234.0	2	1.2	FDJ2CK396K224KB5
160	80	47	42.5	36.0	19.0	37.5	10.2	94.0	282.0	2	1.2	FDJ2CK476K224KB5
160	80	56	42.5	40.0	20.0	37.5	10.2	112.0	336.0	2	1.2	FDJ2CK566K244KB5
160	80	68	42.5	40.0	20.0	37.5	10.2	136.0	408.0	2	1.2	FDJ2CK686K244KB5
160	80	82	42.5	44.0	24.0	37.5	10.2	164.0	492.0	2	1.2	FDJ2CK826K324KB5
160	80	100	42.5	45.0	30.0	37.5	20.3	200.0	600.0	2	1.2	FDJ2CK107K424KD5
160	80	120	42.5	45.0	30.0	37.5	20.3	240.0	720.0	2	1.2	FDJ2CK127K424KD5
160	80	82	57.5	45.0	25.0	52.5	10.2	32.8	98.4	0	1.2	FDJ2CK826M104MB5
160	80	100	57.5	45.0	25.0	52.5	10.2	40.0	120.0	0	1.2	FDJ2CK107M104MB5
160	80	120	57.5	45.0	25.0	52.5	10.2	48.0	144.0	0	1.2	FDJ2CK127M104MB5
160	80	150	57.5	45.0	30.0	52.5	20.3	60.0	180.0	0	1.2	FDJ2CK157M164MD5
160	80	180	57.5	50.0	35.0	52.5	20.3	72.0	216.0	0	1.2	FDJ2CK187M204MD5
160	80	220	57.5	50.0	35.0	52.5	20.3	88.0	264.0	0	1.2	FDJ2CK227M204MD5
250	160	0.15	13.0	11.0	5.0	10.0	\	5.4	16.2	36	0.6	FDJ2EK154C132CL5
250	160	0.22	13.0	12.0	6.0	10.0	\	7.9	23.8	36	0.6	FDJ2EK224C162CL5
250	160	0.33	13.0	12.0	6.0	10.0	\	11.9	35.6	36	0.6	FDJ2EK334C162CL5
250	160	0.33	18.0	11.0	5.0	15.0	\	6.6	19.8	20	0.6	FDJ2EK334E142EL5
250	160	0.47	13.0	16.0	9.0	10.0	\	16.9	50.8	36	0.6	FDJ2EK474C302CL5
250	160	0.47	18.0	13.0	7.0	15.0	\	9.4	28.2	20	0.6	FDJ2EK474E212EL5
250	160	0.68	18.0	13.5	7.5	15.0	\	13.6	40.8	20	0.8	FDJ2EK684E292EL5
250	160	1.0	18.0	14.5	8.5	15.0	\	20.0	60.0	20	0.8	FDJ2EK105E342EL5
250	160	1.5	18.0	18.0	10.0	15.0	\	30.0	90.0	20	0.8	FDJ2EK155E452EL5
250	160	1.5	26.0	17.0	8.5	22.5	\	18.0	54.0	12	0.8	FDJ2EK155F202FL5
250	160	2.2	26.0	19.0	10.0	22.5	\	26.4	79.2	12	0.8	FDJ2EK225F242FL5

# Metallized Polyester Film Capacitors

## FDJ Series - 63 ~ 1000VDC (Automotive Grade DC Film Capacitor)



### Rating and Part Number

Vdc	Vac	Cap Value μF	Dimensions					Peak Current A	Surge Current A	dv/dt V/us	Lead Wire mm	Part Number
			W mm	H mm	T mm	P mm	P1 mm					
250	160	3.3	26.0	22.0	12.0	22.5	\	39.6	118.8	12	0.8	FDJ2EK335F272FL5
250	160	4.7	32.0	20.0	11.0	27.5	\	37.6	112.8	8	0.8	FDJ2EK475G182GL5
250	160	6.8	32.0	22.0	13.0	27.5	\	54.4	163.2	8	0.8	FDJ2EK685G212GL5
250	160	10	32.0	24.5	15.0	27.5	\	80.0	240.0	8	0.8	FDJ2EK106G272GL5
250	160	15	32.0	28.0	18.0	27.5	\	120.0	360.0	8	0.8	FDJ2EK156G332GL5
250	160	18	32.0	31.0	21.0	27.5	\	144.0	432.0	8	0.8	FDJ2EK186G372GL5
250	160	18	42.5	36.0	19.0	37.5	10.2	54.0	162.0	3	1.2	FDJ2EK186K224KB5
250	160	22	42.5	36.0	19.0	37.5	10.2	66.0	198.0	3	1.2	FDJ2EK226K224KB5
250	160	27	42.5	36.0	19.0	37.5	10.2	81.0	243.0	3	1.2	FDJ2EK276K224KB5
250	160	33	42.5	40.0	20.0	37.5	10.2	99.0	297.0	3	1.2	FDJ2EK336K244KB5
250	160	39	42.5	40.0	20.0	37.5	10.2	117.0	351.0	3	1.2	FDJ2EK396K244KB5
250	160	47	42.5	44.0	24.0	37.5	10.2	141.0	423.0	3	1.2	FDJ2EK476K324KB5
250	160	56	42.5	45.0	30.0	37.5	20.3	168.0	504.0	3	1.2	FDJ2EK566K424KD5
250	160	68	42.5	45.0	30.0	37.5	20.3	204.0	612.0	3	1.2	FDJ2EK686K424KD5
250	160	56	57.5	45.0	25.0	52.5	10.2	56.0	168.0	1	1.2	FDJ2EK566M104MB5
250	160	68	57.5	45.0	25.0	52.5	10.2	68.0	204.0	1	1.2	FDJ2EK686M104MB5
250	160	82	57.5	45.0	25.0	52.5	10.2	82.0	246.0	1	1.2	FDJ2EK826M104MB5
250	160	100	57.5	45.0	30.0	52.5	20.3	100.0	300.0	1	1.2	FDJ2EK107M164MD5
250	160	120	57.5	50.0	35.0	52.5	20.3	120.0	360.0	1	1.2	FDJ2EK127M204MD5
400	220	0.068	13.0	11.0	5.0	10.0	\	3.5	10.6	52	0.6	FDJ2GK683C132CL5
400	220	0.1	13.0	12.0	6.0	10.0	\	5.2	15.6	52	0.6	FDJ2GK104C162CL5
400	220	0.15	13.0	16.0	9.0	10.0	\	7.8	23.4	52	0.6	FDJ2GK154C302CL5
400	220	0.15	18.0	13.0	7.0	15.0	\	4.8	14.4	32	0.6	FDJ2GK154E212EL5
400	220	0.22	13.0	16.0	9.0	10.0	\	11.4	34.3	52	0.6	FDJ2GK224C302CL5
400	220	0.22	18.0	13.0	7.0	15.0	\	7.0	21.1	32	0.6	FDJ2GK224E212EL5
400	220	0.33	18.0	13.5	7.5	15.0	\	10.6	31.7	32	0.8	FDJ2GK334E292EL5
400	220	0.47	18.0	18.0	9.0	15.0	\	15.0	45.1	32	0.8	FDJ2GK474E392EL5
400	220	0.68	26.0	17.0	8.5	22.5	\	12.2	36.7	18	0.8	FDJ2GK684F202FL5
400	220	1.0	26.0	19.0	10.0	22.5	\	18.0	54.0	18	0.8	FDJ2GK105F242FL5
400	220	1.5	26.0	20.0	11.0	22.5	\	27.0	81.0	18	0.8	FDJ2GK155F262FL5
400	220	1.5	32.0	20.0	11.0	27.5	\	21.0	63.0	14	0.8	FDJ2GK155G182GL5
400	220	2.2	32.0	24.5	13.0	27.5	\	30.8	92.4	14	0.8	FDJ2GK225G222GL5
400	220	3.3	32.0	24.5	15.0	27.5	\	46.2	138.6	14	0.8	FDJ2GK335G272GL5
400	220	4.7	32.0	28.0	18.0	27.5	\	65.8	197.4	14	0.8	FDJ2GK475G332GL5
630	250	0.022	13.0	11.0	5.0	10.0	\	1.5	4.6	70	0.6	FDJ2LK223C132CL5
630	250	0.033	13.0	12.0	6.0	10.0	\	2.3	6.9	70	0.6	FDJ2LK333C162CL5
630	250	0.033	18.0	11.0	5.0	15.0	\	2.2	6.5	66	0.6	FDJ2LK333E142EL5
630	250	0.047	13.0	12.0	6.0	10.0	\	3.3	9.9	70	0.6	FDJ2LK473C162CL5
630	250	0.047	18.0	13.0	7.0	15.0	\	3.1	9.3	66	0.6	FDJ2LK473E212EL5
630	250	0.068	18.0	13.5	7.5	15.0	\	4.5	13.5	66	0.8	FDJ2LK683E292EL5
630	250	0.10	18.0	13.5	7.5	15.0	\	6.6	19.8	66	0.8	FDJ2LK104E292EL5
630	250	0.10	26.0	14.0	7.0	22.5	\	3.8	11.4	38	0.8	FDJ2LK104F152FL5
630	250	0.15	26.0	17.0	8.5	22.5	\	5.7	17.1	38	0.8	FDJ2LK154F202FL5
630	250	0.22	26.0	17.0	8.5	22.5	\	8.4	25.1	38	0.8	FDJ2LK224F202FL5
630	250	0.33	32.0	20.0	11.0	27.5	\	9.2	27.7	28	0.8	FDJ2LK334G182GL5
630	250	0.47	32.0	20.0	11.0	27.5	\	13.2	39.5	28	0.8	FDJ2LK474G182GL5
630	250	0.68	32.0	24.5	13.0	27.5	\	19.0	57.1	28	0.8	FDJ2LK684G222GL5
630	250	1.0	32.0	24.5	15.0	27.5	\	28.0	84.0	28	0.8	FDJ2LK105G272GL5

# Metallized Polyester Film Capacitors

## FDJ Series - 63 ~ 1000VDC (Automotive Grade DC Film Capacitor)



### Rating and Part Number

Vdc	Vac	Cap Value μF	Dimensions					Peak Current A	Surge Current A	dv/dt V/us	Lead Wire mm	Part Number
			W mm	H mm	T mm	P mm	P1 mm					
630	250	1.5	32.0	28.0	18.0	27.5	\	42.0	126.0	28	0.8	FDJ2LK155G332GL5
1000	350	0.0047	13.0	11.0	5.0	10.0	\	1.2	3.7	260	0.6	FDJ3KK472C132CL5
1000	350	0.0068	13.0	12.0	6.0	10.0	\	1.8	5.3	260	0.6	FDJ3KK682C162CL5
1000	350	0.010	18.0	11.0	5.0	15.0	\	1.3	3.9	130	0.6	FDJ3KK103E142EL5
1000	350	0.015	18.0	13.0	7.0	15.0	\	2.0	5.9	130	0.6	FDJ3KK153E212EL5
1000	350	0.022	18.0	13.5	7.5	15.0	\	2.9	8.6	130	0.8	FDJ3KK223E292EL5
1000	350	0.033	18.0	14.5	8.5	15.0	\	4.3	12.9	130	0.8	FDJ3KK333E342EL5
1000	350	0.033	26.0	14.0	7.0	22.5	\	2.2	6.7	68	0.8	FDJ3KK333F152FL5
1000	350	0.047	26.0	17.0	8.5	22.5	\	3.2	9.6	68	0.8	FDJ3KK473F202FL5
1000	350	0.068	26.0	17.0	8.5	22.5	\	4.6	13.9	68	0.8	FDJ3KK683F202FL5
1000	350	0.10	26.0	19.0	10.0	22.5	\	6.8	20.4	68	0.8	FDJ3KK104F242FL5
1000	350	0.15	32.0	20.0	11.0	27.5	\	7.5	22.5	50	0.8	FDJ3KK154G182GL5
1000	350	0.22	32.0	24.5	13.0	27.5	\	11.0	33.0	50	0.8	FDJ3KK224G222GL5
1000	350	0.47	32.0	35.0	20.0	27.5	\	23.5	70.5	50	0.8	FDJ3KK474G572GL5

**General Technical Data**

Applications	DC Link / DC Filtering
Dielectric	Metallized Polyester Film
Reference Standard	IEC 60384-2
Climatic Category	55/125/56 IEC 60068-1
Operating Temperature Range	-55°C ~ +125°C
Protection	Solvent resistant plastic case UL94 V-0 Thermosetting resin sealing UL 94 V-0 compliant
Installation	Any position
Packaging	Packed in cardboard boxes with protection for the terminals
Storage Conditions	Storage time: ≤24months from the date marked on the label package Average relative humidity per year ≤70% RH≤85% for 30 days randomly distributed throughout the year Dew is absent Temperature: -40°C ~ +85°C
Storage Life	Product that passed less than 2 years from production, No need reconfirmation
RoHS Compliance	Compliant with the restricted substance requirement of Directive 2011/65/EU
Flame Retardant Grade	Flame retardant performance accords with horizontal combustion grade HB and vertical combustion grade V-0.
Application note and limiting conditions	These capacitors are designed only for DC voltage so should not be used for AC line. The continuous peak voltage shall not exceed the rated DC voltage rating

**Construction**

Metallized Film	PE & Al				
Metal Sprayed	Sn/Zn Alloy				
Connection Electrode	Tinned copper wires or Copper-clad Steel Wire				
Case	Plastic Case (UL94V-0)				
Filling	Epoxy Resin (UL94V-0)				
Film Construction	<table style="width: 100%; border: none;"> <tr> <td style="text-align: center; width: 50%;">Mono Structure</td> <td style="text-align: center; width: 50%;">Internal Series Connection</td> </tr> <tr> <td style="text-align: center;"></td> <td style="text-align: center;"></td> </tr> </table>	Mono Structure	Internal Series Connection		
Mono Structure	Internal Series Connection				



### Electrical Characteristics

Voltage Range	63Vdc ~ 1000Vdc
Capacitance Range	0.0047 $\mu$ F ~ 560 $\mu$ F
Capacitance Tolerance	$\pm$ 5% or $\pm$ 10% at +25°C
Capacitance	Measuring Frequency at 1kHz Measuring Voltage: $1 \pm 0.2$ V
Standard Atmospheric Conditions for Static Test	<b>Ambient temperature</b> 15°C to 35°C (If there is any doubt on the results, the measurements shall be made at +20 +/- 5°C) <b>Relative humidity</b> 45% to 75% (If there is any doubt on the results, the measurements shall be made at 60% to 70 %.) <b>Air pressure</b> 86 kPa to 106 kPa.
Voltage Between Terminals $U_{TT}$	$1.5 \times V_R$ VDC for 10 seconds (between terminations) @ +25°C $\pm$ 5°C
Voltage Between Terminals and Case $U_{TC}$	2000V <sub>AC</sub> , 50Hz 60s (at +25 +/-5°C)
Dielectric Dissipation Factor $Tg\Delta 0$	$\leq 5 \times 10^{-3}$
Dissipation factor	$\leq 0.010$ (1.0%) at 1kHz $C \leq 1.0\mu$ F at +25°C $\leq 0.015$ (1.5%) at 1kHz $1.0\mu$ F < $C \leq 10.0\mu$ F at +25°C $\leq 0.030$ (3.0%) at 1kHz $10.0\mu$ F < $C \leq 100.0\mu$ F at +25°C $\leq 0.007$ (0.7%) at 100Hz $C > 100.0\mu$ F at +25°C
Insulation Resistance	>30,000 M $\Omega$ ( $C \leq 0.33\mu$ F & $V_R > 100$ Vdc) at 100VDC 1 minute at +25°C >10,000 M $\Omega$ x $\mu$ F ( $C > 0.33\mu$ F & $V_R > 100$ Vdc) at 100VDC 1 minute at +25°C
Self-Inductance	<1nH per mm of lead spacing
Hot-Spot	$\leq 85^\circ$ C
Life Expectancy	100,000 hours (UR, $\Theta_{hotspot} = 85^\circ$ C)
Failure Rate	100 Fit
Max. Altitude	2000 m
Overvoltage	Maximum duration within one day Apply 110% of rated voltage 30% of on-load duration Apply 115% of rated voltage 30 mins Apply 120% of rated voltage 5 mins Apply 130% of rated voltage 1 min

**Expected Life Curve**

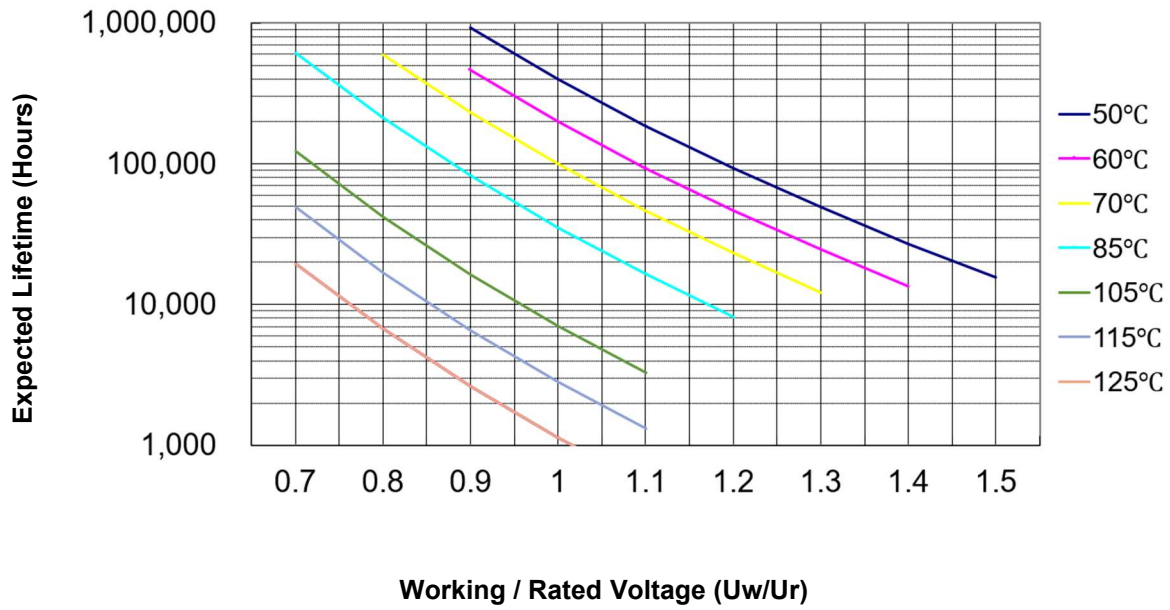

**Derating of Rated Voltage Vs Temperature**

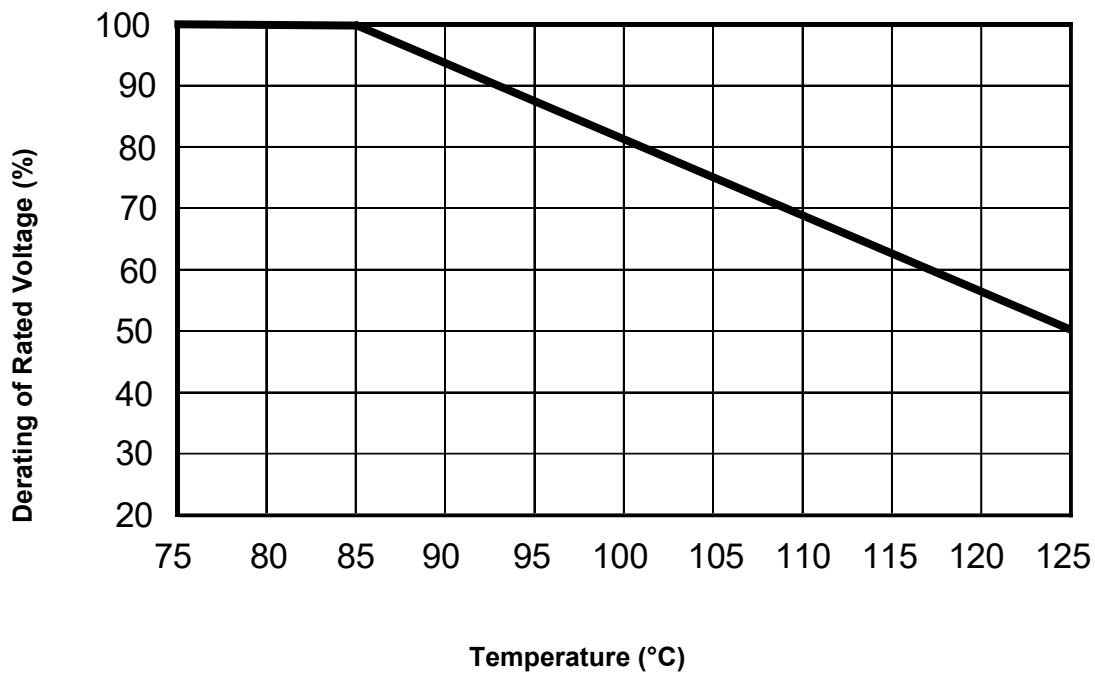

**Wave Soldering Recommendations**

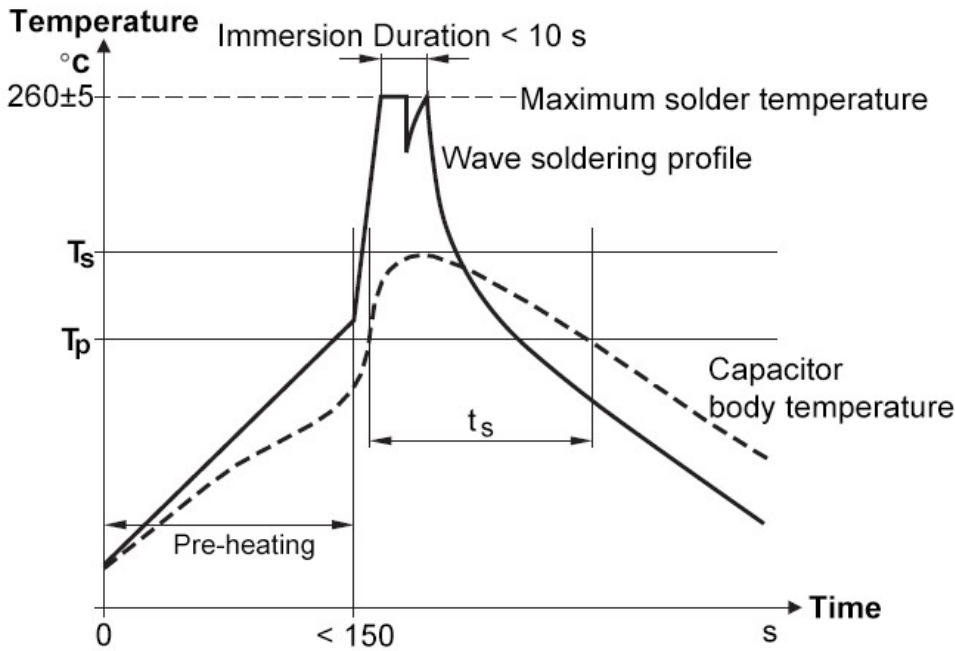

Ts: Capacitor body maximum temperature at wave soldering  
 Tp: Capacitor body maximum temperature at pre-heating

Polypropylene Capacitors	Polyester Capacitors
During pre-heating: $T_p \leq 110^\circ\text{C}$ During soldering: $T_s \leq 120^\circ\text{C}$ , $t_s \leq 60$	During pre-heating: $T_p \leq 130^\circ\text{C}$ During soldering: $T_s \leq 160^\circ\text{C}$ , $t_s \leq 60\text{s}$

**Packaging Information**

Inner Box Specifications (Dimensions)			
Box #	L ±3mm	W±3mm	H ±3mm
# 1	331	331	25
# 2	331	331	35
# 3	331	331	50
# 4	331	331	80
# 5	350	170	35
# 6	350	170	50
# 7	350	170	80

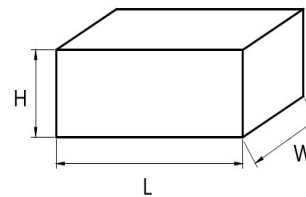

Outer Box Specifications (Dimensions)			
Box #	L ±5mm	W±5mm	H ±5mm
# 1	350	340	265
# 2	370	360	350

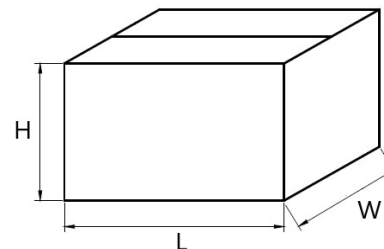

**Packaging Quantity**

P	Code	W	H	T	Long Leads	Short Leads
10.0	C13	13.0	11.0	5.0	1200	1426
	C16	13.0	12.0	6.0	1200	1173
	C30	13.0	16.0	9.0	1200	782
	E14	18.0	11.0	5.0	800	1054
15.0	E21	18.0	13.0	7.0	800	748
	E29	18.0	13.5	7.5	800	697
	E34	18.0	14.5	8.5	600	612
	E39	18.0	18.0	9.0	600	578
	E45	18.0	18.0	10.0	600	527
22.5	F15	26.0	14.0	7.0	600	528
	F20	26.0	17.0	8.5	600	432
	F24	26.0	19.0	10.0	400	372
	F26	26.0	20.0	11.0	400	336
	F27	26.0	22.0	12.0	400	300
27.5	G15	32.0	18.0	9.0	200	306
	G18	32.0	20.0	11.0	200	252
	G21	32.0	22.0	13.0	200	207
	G22	32.0	24.5	13.0	200	207
	G27	32.0	24.5	15.0	200	180
	G33	32.0	28.0	18.0	100	153
	G37	32.0	31.0	21.0	100	126
	G56	32.0	31.0	31.0	100	90
37.5	G57	32.0	35.0	20.0	100	144
	K22	42.5	36.0	19.0	-	112
	K24	42.5	40.0	20.0	-	105
	K32	42.5	44.0	24.0	-	91
52.5	K42	42.5	45.0	30.0	-	70
	M10	57.5	45.0	25.0	-	60
	M16	57.5	45.0	30.0	-	50
	M20	57.5	50.0	35.0	-	45

### Cautions and Warnings

- Don't exceed the upper category temperature.
- For longtime storage, maximum relative humidity 80%, no dew allowed on the capacitor.
- Do not use or store capacitor in corrosive atmosphere, in the dusty environment's regular maintenance and cleaning especially of the terminals is required to avoid conductive path between terminal / or terminal and ground.
- Don't apply any mechanical stress to the capacitor terminals, and avoid any compressive, tensile or flexural stress.
- Don't move the capacitor after fixed to the PC board, and don't pick up the PC board by the fixed capacitor.
- Don't place the capacitor on a PC board whose holes pitch differs from the specified space.
- Avoid overload of the capacitors
- Do not have unlimited service life expectancy, the max service life expectancy may vary depending on the application the capacitor is used in.

### Disclaimer

All product, product specifications and data in this datasheet are subject to change without notice to improve reliability, function or design or otherwise. The customer is responsible for checking and verifying the extent to which the Information contained in this publication is applicable to an order at the time the order is placed. All Information given herein is believed to be accurate and reliable, but it is presented without guarantee, warranty, or responsibility of any kind, expressed or implied.

In individual cases, a malfunction of electronic components or failure before the end of their usual service life cannot be completely ruled out in the current state of the art, even if they are operated as specified. In customer application requiring a very high level of operational safety and especially in customer applications in which the malfunction or failure of an electronic component could endanger human life or health (e.g. in accident prevention or lifesaving systems), it must therefore be ensured by means of suitable design of the customer application or other action taken by the customer (e.g. installation of protective circuitry or redundancy) that no injury or damage is sustained by third parties in the event of malfunction or failure of an electronic component.

We continue efforts to improve our products. Therefore, the products described in this publication may change from time to time. The same is true of the corresponding product specifications. Please check therefore to what extent product descriptions and specifications contained in this publication are still applicable before or when you place an order. We also reserve the right to discontinue production and delivery of products. Consequently, we cannot guarantee that all products named in this publication will always be available.

No license, express or implied, by estoppel or otherwise, to any intellectual property rights is granted by this document or by any conduct of Aishi. Product names and markings noted herein may be trademarks of their respective owners.