

Double Metallized Polypropylene Film Snubber Capacitors

FSA Series - 850 ~ 2000VDC (Radial, 2 or 4 Leads)



Overview

The FSA capacitor is constructed of metallized polypropylene film with double-sided metallized film encapsulated with epoxy resin in a plastic box, with 2 or 4 tinned copper wires.

Applications

Widely used in high voltage, high frequency circuit, snubber and SCR commutating circuits.

Features

- High ripple current
- Self-healing property
- Low losses
- Small inherent temperature rise
- High contact reliability



Qualification

Reference Standard	IEC 61071
Climate Category	40/85/56 IEC 60068-1



Marking

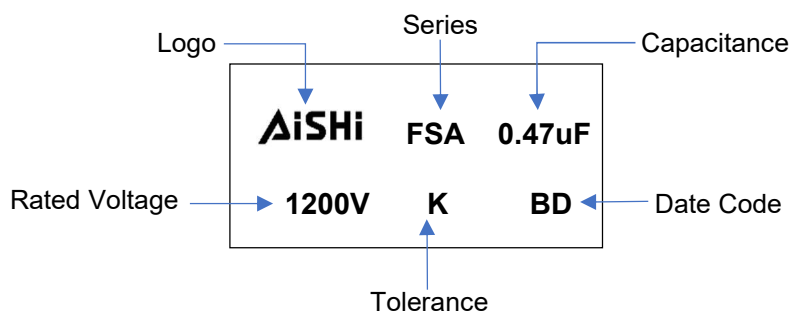

Manufacturing Date Code

Year	Code	Month	Code
2018	A	Jan	1
2019	B	Feb	2
2020	C	Mar	3
2021	D	Apr	4
2022	E	May	5
2023	F	Jun	6

Year	Code	Month	Code
2024	G	Jul	7
2025	H	Aug	8
2026	J	Sep	9
2027	K	Oct	A
2028	L	Nov	N
2029	M	Dec	D

Part Number System

F	SA	3B	K	474	G40	2GL	5
Capacitor Type	Series	Voltage (VDC)	Tolerance	Capacitance (pF)	Size Code	Terminal Code	Lead Length Code
F = Film	Snubber Capacitor, Double-sided Metallized PP Film	850=2P 1000=3K 1200=3B 1600=3W 2000=3D	J = ±5% K = ±10%	First two digits = significant figures. Third digit = Number of zeros.	Refer to Size Code Table	Refer to Terminal Code Table	Refer to Lead Length Code Table

Terminal Code

Digit One (Lead/Terminal Type)		Digit Two (Lead Space)		Digit Three (Lead Ipsilateral)	
2 leads for long	L	27.5mm	G	10.2mm	B
2 leads for straight cut	2	37.5mm	K	12.7mm	G
2 leads for forming cut	E	57.5mm	M	20.3mm	D
4 leads for straight cut	4			N/A	L

Lead Length Code

Lead Length	
3.0mm	3
4.0mm	4
5.0mm	5
7.0mm	7
20.0mm min	L

Dimension (mm)

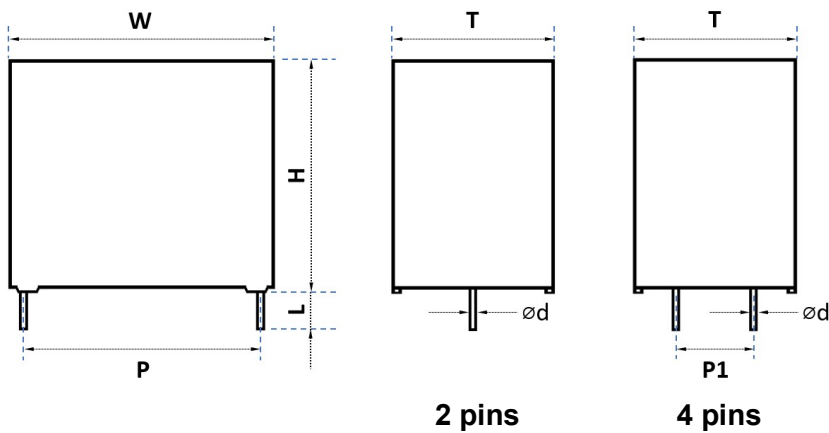

Size Code Table (mm)

Size Code	Dimension						Pitch				Ød		
	W	Tolerance	H	Tolerance	T	Tolerance	P	Tolerance	P1	Tolerance	4 Leads	2 Leads	Tolerance
G18	32.0	0.8	20.0	0.8	11.0	0.8	27.5	0.5	/	/	/	0.8	0.05
G21	32.0	0.8	22.0	0.8	13.0	0.8	27.5	0.5	/	/	/	0.8	0.05
G22	32.0	0.8	24.5	0.8	13.0	0.8	27.5	0.5	/	/	/	0.8	0.05
G26	32.0	0.8	28.0	0.8	14.0	0.8	27.5	0.5	/	/	/	0.8	0.05
G34	32.0	0.8	33.0	0.8	18.0	0.8	27.5	0.5	/	/	/	0.8	0.05
G40	32.0	0.8	37.0	0.8	22.0	0.8	27.5	0.5	/	/	/	0.8	0.05
K21	42.5	0.8	32.0	0.8	19.0	0.8	37.5	0.5	10.2	0.5	1.2	1.0	0.05
K24	42.5	0.8	40.0	0.8	20.0	0.8	37.5	0.5	10.2	0.5	1.2	1.0	0.05
K32	42.5	0.8	44.0	0.8	24.0	0.8	37.5	0.5	10.2	0.5	1.2	1.0	0.05
K37	42.5	0.8	37.0	0.8	28.0	0.8	37.5	0.5	10.2	0.5	1.2	1.0	0.05
K42	42.5	0.8	45.0	0.8	30.0	0.8	37.5	0.5	20.3	0.5	1.2	1.0	0.05
M16	57.5	1.0	45.0	1.0	30.0	1.0	52.5	0.5	20.3	0.5	1.2	1.2	0.05
M20	57.5	1.0	50.0	1.0	35.0	1.0	52.5	0.5	20.3	0.5	1.2	1.2	0.05

Double Metallized Polypropylene Film Snubber Capacitors

FSA Series - 850 ~ 2000VDC (Radial, 2 or 4 Leads)



Rating and Part Number

Vdc	Cap Value μF	Dimensions					I rms 100KHz @70°C A	Peak Current A	Surge Current A	ESR 100KHz @70°C mΩ	ESL nH	dv/dt V/us	Lead Wire mm	Part Number
		W	H	T	P	P1								
		mm	mm	mm	mm	mm								
850	0.15	32.0	20.0	11.0	27.5	\	8.0	195	585	14.5	24	1300	0.8	FSA2PK154G182GL5
850	0.22	32.0	22.0	13.0	27.5	\	10.0	286	858	10.5	24	1300	0.8	FSA2PK224G212GL5
850	0.33	32.0	28.0	14.0	27.5	\	13.0	429	1287	7.6	26	1300	0.8	FSA2PK334G262GL5
850	0.47	32.0	33.0	18.0	27.5	\	14.0	611	1833	5.8	26	1300	0.8	FSA2PK474G342GL5
850	0.68	32.0	37.0	22.0	27.5	\	16.0	884	2652	4.6	28	1300	0.8	FSA2PK684G402GL5
850	1.0	42.5	40.0	20.0	37.5	10.2	22.0	800	2400	5.9	30	800	1.2	FSA2PK105K244KB5
850	2.0	42.5	44.0	24.0	37.5	10.2	29.0	1600	4800	3.9	30	800	1.2	FSA2PK205K324KB5
850	3.0	57.5	45.0	30.0	52.5	20.3	29.0	1500	4500	5.0	35	500	1.2	FSA2PK305M164MD5
850	4.0	57.5	45.0	30.0	52.5	20.3	29.0	2000	6000	4.2	35	500	1.2	FSA2PK405M164MD5
850	5.0	57.5	50.0	35.0	52.5	20.3	29.0	2500	7500	3.9	35	500	1.2	FSA2PK505M204MD5
1000	0.15	32.0	20.0	11.0	27.5	\	8.0	210	630	14.0	24	1400	0.8	FSA3KK154G182GL5
1000	0.22	32.0	22.0	13.0	27.5	\	9.0	308	924	9.9	24	1400	0.8	FSA3KK224G212GL5
1000	0.33	32.0	28.0	14.0	27.5	\	10.0	462	1386	7.2	26	1400	0.8	FSA3KK334G262GL5
1000	0.47	32.0	33.0	18.0	27.5	\	12.0	658	1974	5.6	26	1400	0.8	FSA3KK474G342GL5
1000	0.68	32.0	37.0	22.0	27.5	\	14.0	952	2856	4.4	28	1400	0.8	FSA3KK684G402GL5
1000	1.0	42.5	40.0	20.0	37.5	10.2	16.0	900	2700	5.5	30	900	1.2	FSA3KK105K244KB5
1000	1.5	42.5	37.0	28.0	37.5	10.2	16.0	1350	4050	4.2	30	900	1.2	FSA3KK155K374KB5
1000	2.0	42.5	45.0	30.0	37.5	20.3	18.0	1800	5400	3.7	30	900	1.2	FSA3KK205K424KD5
1000	2.2	42.5	45.0	30.0	37.5	20.3	18.0	1980	5940	3.6	30	900	1.2	FSA3KK225K424KD5
1000	3.0	57.5	45.0	30.0	52.5	20.3	20.0	1650	4950	4.7	35	550	1.2	FSA3KK305M164MD5
1000	4.0	57.5	50.0	35.0	52.5	20.3	22.0	2200	6600	4.2	35	550	1.2	FSA3KK405M204MD5
1000	4.7	57.5	50.0	35.0	52.5	20.3	24.0	2585	7755	3.9	35	550	1.2	FSA3KK475M204MD5
1200	0.1	32.0	20.0	11.0	27.5	\	7.0	160	480	18.5	24	1600	0.8	FSA3BK104G182GL5
1200	0.15	32.0	22.0	13.0	27.5	\	10.0	240	720	12.8	24	1600	0.8	FSA3BK154G212GL5
1200	0.22	32.0	28.0	14.0	27.5	\	12.0	352	1056	9.2	26	1600	0.8	FSA3BK224G262GL5
1200	0.33	32.0	33.0	18.0	27.5	\	14.0	528	1584	6.7	26	1600	0.8	FSA3BK334G342GL5
1200	0.47	32.0	37.0	22.0	27.5	\	14.0	752	2256	5.3	28	1600	0.8	FSA3BK474G402GL5
1200	0.68	42.5	40.0	20.0	37.5	10.2	16.0	680	2040	6.6	30	1000	1.2	FSA3BK684K244KB5
1200	1.0	42.5	40.0	20.0	37.5	10.2	18.0	1000	3000	5.1	30	1000	1.2	FSA3BK105K244KB5
1200	1.2	42.5	37.0	28.0	37.5	10.2	18.0	1200	3600	4.4	30	1000	1.2	FSA3BK125K374KB5
1200	2.0	57.5	45.0	30.0	52.5	20.3	20.0	1200	3600	5.5	35	600	1.2	FSA3BK205M164MD5
1200	2.2	57.5	45.0	30.0	52.5	20.3	20.0	1320	3960	5.2	35	600	1.2	FSA3BK225M164MD5
1200	2.5	57.5	45.0	30.0	52.5	20.3	22.0	1500	4500	4.8	35	600	1.2	FSA3BK255M164MD5
1200	3.0	57.5	50.0	35.0	52.5	20.3	22.0	1800	5400	4.5	35	600	1.2	FSA3BK305M204MD5
1200	3.3	57.5	50.0	35.0	52.5	20.3	24.0	1980	5940	4.1	35	600	1.2	FSA3BK335M204MD5
1600	0.1	32.0	22.0	13.0	27.5	\	8.0	190	570	13.5	24	1900	0.8	FSA3WK104G212GL5
1600	0.15	32.0	24.5	13.0	27.5	\	9.0	285	855	10.5	24	1900	0.8	FSA3WK154G222GL5
1600	0.18	32.0	28.0	14.0	27.5	\	10.0	342	1026	9.5	26	1900	0.8	FSA3WK184G262GL5
1600	0.22	32.0	33.0	18.0	27.5	\	12.0	418	1254	8.0	26	1900	0.8	FSA3WK224G342GL5
1600	0.27	32.0	33.0	18.0	27.5	\	14.0	513	1539	7.0	26	1900	0.8	FSA3WK274G342GL5
1600	0.33	32.0	37.0	22.0	27.5	\	15.0	627	1881	6.8	28	1900	0.8	FSA3WK334G402GL5
1600	0.39	32.0	37.0	22.0	27.5	\	15.0	741	2223	6.5	28	1900	0.8	FSA3WK394G402GL5
1600	0.47	42.5	32.0	19.0	37.5	\	16.0	588	1763	6.0	30	1250	1.0	FSA3WK474K212KL5
1600	0.68	42.5	40.0	20.0	37.5	10.2	18.0	850	2550	5.0	30	1250	1.2	FSA3WK684K244KB5
1600	0.82	42.5	44.0	24.0	37.5	10.2	18.0	1025	3075	5.0	30	1250	1.2	FSA3WK824K324KB5
1600	1.0	42.5	45.0	30.0	37.5	20.3	19.0	1250	3750	4.8	30	1250	1.2	FSA3WK105K424KD5
1600	1.2	42.5	45.0	30.0	37.5	20.3	19.0	1500	4500	4.8	30	1250	1.2	FSA3WK125K424KD5
1600	1.5	57.5	45.0	30.0	52.5	20.3	20.0	1125	3375	4.5	35	750	1.2	FSA3WK155M164MD5

Rating and Part Number

Vdc	Cap Value	Dimensions					I _{rms} 100KHz @70°C	Peak Current	Surge Current	ESR 100KHz @70°C	ESL	dv/dt	Lead Wire	Part Number
		W	H	T	P	P1								
	μF	mm	mm	mm	mm	mm	A	A	A	mΩ	nH	V/us	mm	
1600	2.0	57.5	50.0	35.0	52.5	20.3	22.0	1500	4500	4.2	35	750	1.2	FSA3WK205M204MD5
2000	0.033	32.0	20.0	11.0	27.5	\	5.0	76	228	42.5	24	2300	0.8	FSA3DK333G182GL5
2000	0.047	32.0	20.0	11.0	27.5	\	6.0	108	324	30.5	24	2300	0.8	FSA3DK473G182GL5
2000	0.068	32.0	22.0	13.0	27.5	\	8.0	156	469	20.8	24	2300	0.8	FSA3DK683G212GL5
2000	0.1	32.0	28.0	14.0	27.5	\	10.0	230	690	15.2	26	2300	0.8	FSA3DK104G262GL5
2000	0.15	32.0	33.0	18.0	27.5	\	15.0	345	1035	10.8	26	2300	0.8	FSA3DK154G342GL5
2000	0.22	32.0	33.0	18.0	27.5	\	17.0	506	1518	7.8	26	2300	0.8	FSA3DK224G342GL5
2000	0.33	42.5	40.0	20.0	37.5	10.2	16.0	462	1386	9.4	30	1400	1.2	FSA3DK334K244KB5
2000	0.47	42.5	44.0	24.0	37.5	10.2	18.0	658	1974	8.3	30	1400	1.2	FSA3DK474K324KB5
2000	0.68	42.5	45.0	30.0	37.5	20.3	20.0	952	2856	5.5	30	1400	1.2	FSA3DK684K424KD5
2000	1.0	57.5	45.0	30.0	52.5	20.3	22.0	850	2550	7.3	35	850	1.2	FSA3DK105M164MD5
2000	1.5	57.5	50.0	35.0	52.5	20.3	24.0	1275	3825	5.6	35	850	1.2	FSA3DK155M204MD5

General Technical Data

Applications	High voltage, high frequency and pulse circuit / IGBT Modules Protection
Dielectric	Double Metallized Polypropylene Film
Reference Standard	IEC 61071
Climatic Category	40/85/56 IEC 60068-1
Operating Temperature Range	-40°C ~ +105°C (+85°C observing voltage must be de-rating at 1.35% per °C)
Protection	Solvent resistant plastic case UL94 V-0 Thermosetting resin sealing UL 94 V-0 compliant
Installation	Any position
Packaging	Packed in cardboard boxes with protection for the terminals
Storage Conditions	Storage time: ≤24months from the date marked on the label package Average relative humidity per year ≤70% RH≤85% for 30 days randomly distributed throughout the year Dew is absent Temperature: -40°C ~ +85°C
Storage Life	Product that passed less than 2 years from production, No need reconfirmation
RoHS Compliance	Compliant with the restricted substance requirement of Directive 2011/65/EU
Application note and limiting conditions	These capacitors are designed only for DC voltage so should not be used for AC line. The continuous peak voltage shall not exceed the rated DC voltage rating

Construction

Metallized Film	OPP & Al (Single Side Metallized and Double Sided Metallized)
Metal Sprayed	Sn/Zn Alloy
Connection Electrode	Tin-plated Copper Wire
Case	Plastic Case (UL94V-0)
Filling	Epoxy Resin (UL94V-0)
Film Construction	<p style="text-align: center;">Internal Series Connection</p> 

Electrical Characteristics

Voltage Range	850Vdc ~ 2000Vdc
Capacitance Range	0.033 μ F ~ 5.0 μ F
Capacitance Tolerance	\pm 5% or \pm 10% at +25°C
Capacitance	Measuring Frequency at 1kHz Measuring Voltage: 1 \pm 0.2V
Standard Atmospheric Conditions for Static Test	Ambient temperature 15°C to 35°C (If there is any doubt on the results, the measurements shall be made at +20 +/- 5°C) Relative humidity 45% to 75% (If there is any doubt on the results, the measurements shall be made at 60% to 70 %.) Air pressure 86 kPa to 106 kPa.
Voltage Between Terminals U_{TT}	1.5 x V_R VDC for 10 seconds (between terminations) @ +25°C \pm 5°C
Voltage Between Terminals and Case U_{TC}	3000VAC, 60s (at+20/+2°C)
Dielectric Dissipation Factor $Tg\delta_0$	$\leq 2 \times 10^{-4}$
Dissipation factor	0.0010 (0.1%) at 25°C, 1kHz
Insulation Resistance	R between leads, for C \leq 0.33 μ F at 100 V; 1 min > 100 000 M Ω RC between leads, for C > 0.33 μ F at 100 V; 1 min > 30 000 s
Self-Inductance	<1nH per mm of lead spacing
Hot-Spot	$\leq 85^\circ\text{C}$
Life Expectancy	100,000 hours (U_R , $\Theta_{\text{hotspot}}=85^\circ\text{C}$)
Failure Rate	100 Fit
Max. Altitude	2000 m
Overvoltage	Maximum duration within one day
Apply 110% of rated voltage	30% of on-load duration
Apply 115% of rated voltage	30 mins
Apply 120% of rated voltage	5 mins
Apply 130% of rated voltage	1 min

Expected Life Curve

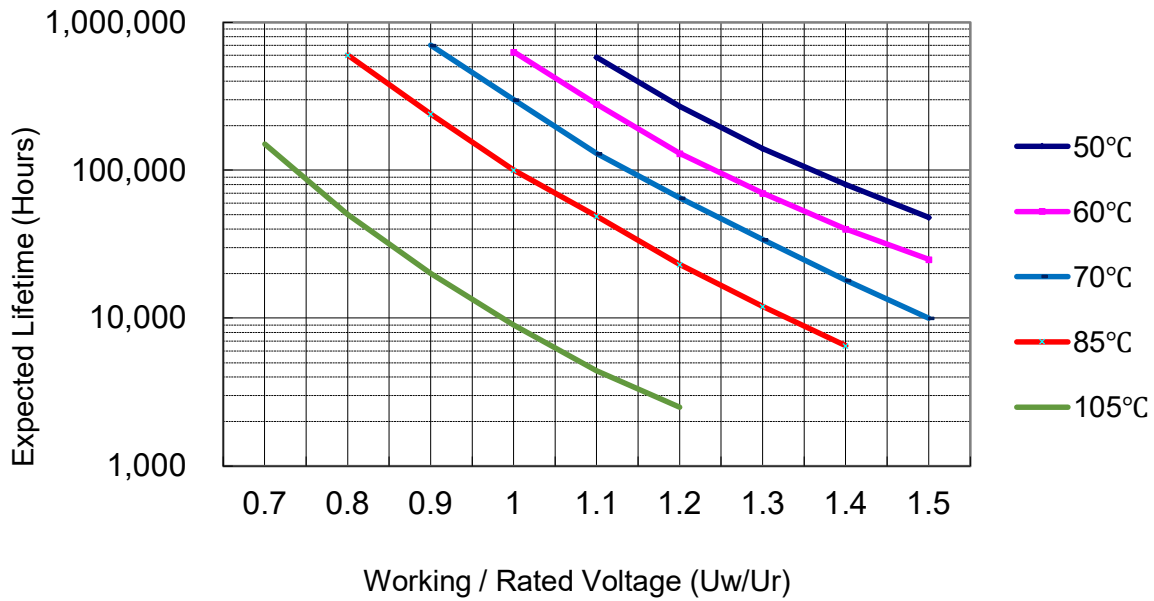

Derating of Rated Voltage Vs Temperature

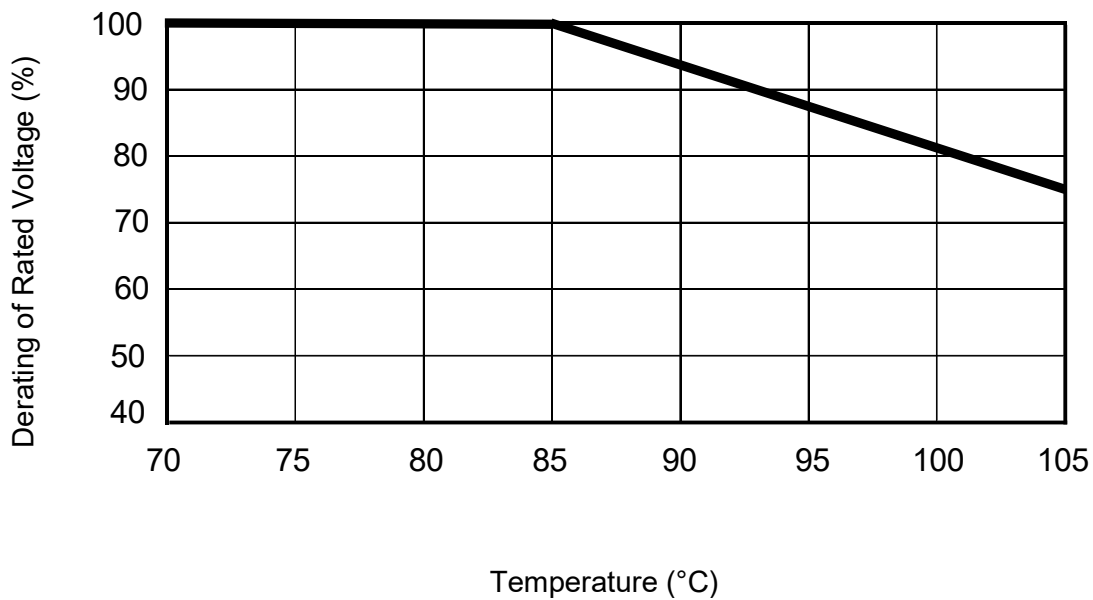

Wave Soldering Recommendations

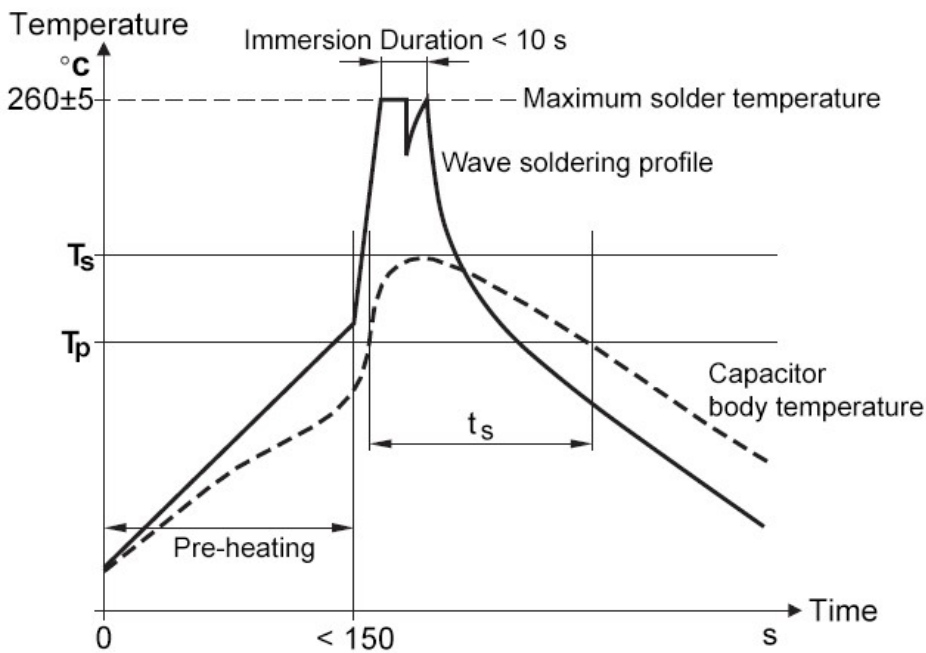

Ts: Capacitor body maximum temperature at wave soldering
 Tp: Capacitor body maximum temperature at pre-heating

Polypropylene Capacitors	Polyester Capacitors
During pre-heating: Tp≤110°C During soldering: Ts ≤120°C, ts≤60	During pre-heating: Tp≤130°C During soldering: Ts≤160°C, ts≤60s

Packaging Information

Inner Box Specifications (Dimensions)			
Box #	L ±3mm	W±3mm	H ±3mm
# 1	331	331	25
# 2	331	331	35
# 3	331	331	50
# 4	331	331	80
# 5	350	170	35
# 6	350	170	50
# 7	350	170	80

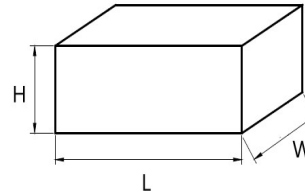

Outer Box Specifications (Dimensions)			
Box #	L ±5mm	W±5mm	H ±5mm
# 1	350	340	265
# 2	370	360	350

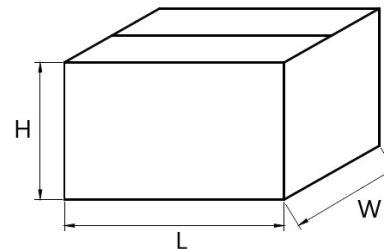

Packaging Quantity

P	Code	W	H	T	Bulk	Ammo
27.5	G18	32.0	20.0	11.0	200.0	252
27.5	G21	32.0	22.0	13.0	200.0	207
27.5	G22	32.0	24.5	13.0	200.0	207
27.5	G26	32.0	28.0	14.0	200.0	198
27.5	G34	32.0	33.0	18.0	100.0	153
27.5	G40	32.0	37.0	22.0	100.0	126
37.5	K21	42.5	32.0	19.0	-	112
37.5	K24	42.5	40.0	20.0	-	105
37.5	K32	42.5	44.0	24.0	-	91
37.5	K37	42.5	37.0	28.0	-	77
37.5	K42	42.5	45.0	30.0	-	70
52.5	M16	57.5	45.0	30.0	-	50
52.5	M20	57.5	50.0	35.0	-	45

Cautions and Warnings

- Don't exceed the upper category temperature.
- For longtime storage, maximum relative humidity 80%, no dew allowed on the capacitor.
- Do not use or store capacitor in corrosive atmosphere, in the dusty environment's regular maintenance and cleaning especially of the terminals is required to avoid conductive path between terminal / or terminal and ground.
- Don't apply any mechanical stress to the capacitor terminals, and avoid any compressive, tensile or flexural stress.
- Don't move the capacitor after fixed to the PC board, and don't pick up the PC board by the fixed capacitor.
- Don't place the capacitor on a PC board whose holes pitch differs from the specified space.
- Avoid overload of the capacitors
- Do not have unlimited service life expectancy, the max service life expectancy may vary depending on the application the capacitor is used in.

Disclaimer

All product, product specifications and data in this datasheet are subject to change without notice to improve reliability, function or design or otherwise. The customer is responsible for checking and verifying the extent to which the Information contained in this publication is applicable to an order at the time the order is placed. All Information given herein is believed to be accurate and reliable, but it is presented without guarantee, warranty, or responsibility of any kind, expressed or implied.

In individual cases, a malfunction of electronic components or failure before the end of their usual service life cannot be completely ruled out in the current state of the art, even if they are operated as specified. In customer application requiring a very high level of operational safety and especially in customer applications in which the malfunction or failure of an electronic component could endanger human life or health (e.g. in accident prevention or lifesaving systems), it must therefore be ensured by means of suitable design of the customer application or other action taken by the customer (e.g. installation of protective circuitry or redundancy) that no injury or damage is sustained by third parties in the event of malfunction or failure of an electronic component.

We continue efforts to improve our products. Therefore, the products described in this publication may change from time to time. The same is true of the corresponding product specifications. Please check therefore to what extent product descriptions and specifications contained in this publication are still applicable before or when you place an order. We also reserve the right to discontinue production and delivery of products. Consequently, we cannot guarantee that all products named in this publication will always be available.

No license, express or implied, by estoppel or otherwise, to any intellectual property rights is granted by this document or by any conduct of Aishi. Product names and markings noted herein may be trademarks of their respective owners.