

Overview

The FYT series is constructed of metallized polypropylene film encapsulated with self-extinguishing resin in a box of material meeting the requirement of UL94V-0. This FYT series robustness design is suitable for high humidity and high temperature environmental and compliant to THB Grade IIIB.

Applications

Use in EMI filter in line-to-ground and line-by-pass applications requiring Y2 safety classification. Suitable for use in situations where failure of the capacitor would not lead to danger of electric shock.

Features

- High stability of capacitance
- High temperature (110°C)
- Self-healing property
- Over voltage stress withstanding
- Flame-retardant plastic case and resin
- Suitable for harsh environment conditions
- THB Grade IIIB (85°C, 85% RH, 1000h at U_{RAC})

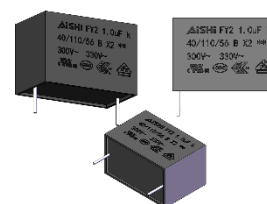

Approvals

Marking	Standard	File Number
	UL 60384-14 CAN/CSA-E60384-14	E500538
	IEC 60384-14:2013 IEC 60384-14:2013/AMD1:2016	40052687
	IEC 60384-14:2013+AMD1:2016 CQC11-471112-2015	CQC20001280148

Marking

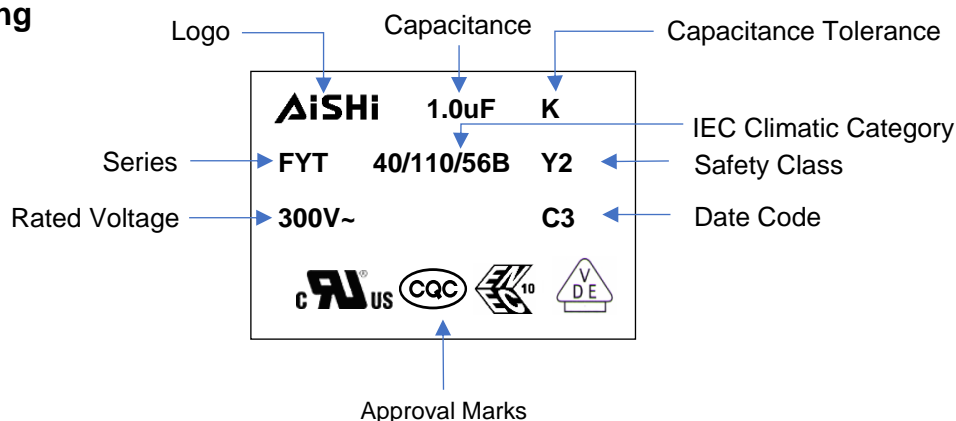

Manufacturing Date Code

Year	Code	Month	Code
2018	A	Jan	1
2019	B	Feb	2
2020	C	Mar	3
2021	D	Apr	4
2022	E	May	5
2023	F	Jun	6

Year	Code	Month	Code
2024	G	Jul	7
2025	H	Aug	8
2026	J	Sep	9
2027	K	Oct	A
2028	L	Nov	N
2029	M	Dec	D

Part Number System

F	YT	30	K	105	K24	2KL	5
Capacitor Type	Series	Voltage (VAC)	Tolerance	Capacitance (pF)	Size Code	Terminal Code	Lead Length Code
F = Film	Class Y2, THB Type, Metallized PP Film	30=300Vac	J = ±5% K = ±10% M = ±20%	First two digits = significant figures. Third digit = Number of zeros.	Refer to Size Code Table	Refer to Terminal Code Table	Refer to Lead Length Table

Terminal Code

Digit One (Lead/Terminal Type)		Digit Two (Lead Space)		Digit Three (Lead Ipsilateral)	
2 leads for long	L	10.0mm	C	5.1mm	A
2 leads for straight cut	2	15.0mm	E	7.5mm	C
2 leads for forming cut	E	22.5mm	F	10.2mm	B
4 leads for straight cut	4	27.5mm	G	12.7mm	G
Taping	T	37.5mm	K	20.3mm	D
Taping Straight	V	N/A	N	N/A	L

Lead Length Code

Lead Length	
3.0mm	3
4.0mm	4
5.0mm	5
7.0mm	7
Taping	T
N/A	N

Dimension (mm)

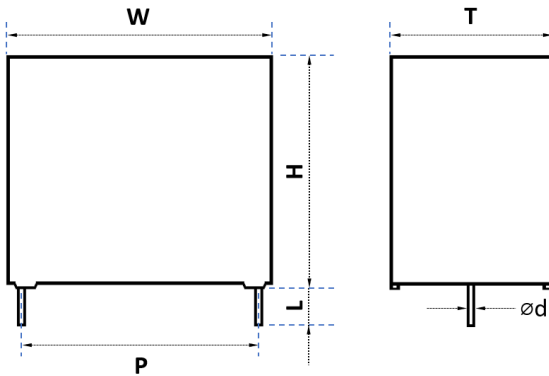

2 pins

Size Code Table (mm)

Size Code	Dimension						Pitch		Lead Wire	
	W	Tolerance	H	Tolerance	T	Tolerance	P	Tolerance	Ød	Tolerance
C13	13	0.5	11	0.5	5	0.5	10	0.5	0.6	0.05
C16	13	0.5	12	0.5	6	0.5	10	0.5	0.6	0.05
E14	18	0.5	11	0.5	5	0.5	15	0.5	0.6	0.05
E17	18	0.5	12	0.5	6	0.5	15	0.5	0.6	0.05
E29	18	0.5	13.5	0.5	7.5	0.5	15	0.5	0.8	0.05
E34	18	0.5	14.5	0.5	8.5	0.5	15	0.5	0.8	0.05
E47	18	0.5	19	0.5	11	0.5	15	0.5	0.8	0.05
F14	26	0.8	15.5	0.8	6	0.8	22.5	0.5	0.6	0.05
F17	26	0.5	16.5	0.5	7	0.5	22.5	0.5	0.8	0.05
F20	26	0.8	17	0.8	8.5	0.8	22.5	0.5	0.8	0.05
F24	26	0.5	19	0.5	10	0.5	22.5	0.5	0.8	0.05
F27	26	0.5	22	0.5	12	0.5	22.5	0.5	0.8	0.05
F36	26	0.8	25	0.8	15	0.8	22.5	0.5	0.8	0.05
G15	32	0.8	18	0.8	9	0.8	27.5	0.5	0.8	0.05
G18	32	0.8	20	0.8	11	0.8	27.5	0.5	0.8	0.05
G21	32	0.8	22	0.8	13	0.8	27.5	0.5	0.8	0.05
G26	32	0.8	28	0.8	14	0.8	27.5	0.5	0.8	0.05
G33	32	0.8	28	0.8	18	0.8	27.5	0.5	0.8	0.05
G34	32	0.8	33	0.8	18	0.8	27.5	0.5	0.8	0.05
G40	32	0.8	37	0.8	22	0.8	27.5	0.5	0.8	0.05
K11	42	0.8	24	0.8	13	0.8	37.5	0.5	1.0	0.05
K17	42	0.8	28	0.8	17	0.8	37.5	0.5	1.0	0.05
K21	42	0.8	32	0.8	19	0.8	37.5	0.5	1.0	0.05
K24	42	0.8	40	0.8	20	0.8	37.5	0.5	1.0	0.05

Rating and Part Number

Vac	Vdc	Cap Value μF	Dimensions				Peak Current A	Surge Current A	dv/dt V/us	Lead Wire mm	Part Number
			W mm	H mm	T mm	P mm					
300	1500	0.0047	13	11	5	10	3.76	11.28	800	0.6	FYT30K472C132CL5
300	1500	0.0047	13	12	6	10	3.76	11.28	800	0.6	FYT30K472C162CL5
300	1500	0.0068	13	12	6	10	5.44	16.32	800	0.6	FYT30K682C162CL5
300	1500	0.01	13	12	6	10	8	24	800	0.6	FYT30K103C162CL5
300	1500	0.015	13	12	6	10	12	36	800	0.6	FYT30K153C162CL5
300	1500	0.0047	18	11	5	15	2.82	8.46	600	0.6	FYT30K472E142EL5
300	1500	0.0056	18	11	5	15	3.36	10.08	600	0.6	FYT30K562E142EL5
300	1500	0.0068	18	11	5	15	4.08	12.24	600	0.6	FYT30K682E142EL5
300	1500	0.0082	18	11	5	15	4.92	14.76	600	0.6	FYT30K822E142EL5
300	1500	0.01	18	11	5	15	6	18	600	0.6	FYT30K103E142EL5
300	1500	0.015	18	11	5	15	9	27	600	0.6	FYT30K153E142EL5
300	1500	0.018	18	12	6	15	10.8	32.4	600	0.6	FYT30K183E172EL5
300	1500	0.022	18	12	6	15	13.2	39.6	600	0.6	FYT30K223E172EL5
300	1500	0.033	18	13.5	7.5	15	19.8	59.4	600	0.8	FYT30K333E292EL5
300	1500	0.039	18	13.5	7.5	15	23.4	70.2	600	0.8	FYT30K393E292EL5
300	1500	0.047	18	14.5	8.5	15	28.2	84.6	600	0.8	FYT30K473E342EL5
300	1500	0.068	18	19	11	15	40.8	122.4	600	0.8	FYT30K683E472EL5
300	1500	0.082	18	19	11	15	49.2	147.6	600	0.8	FYT30K823E472EL5
300	1500	0.047	26	15.5	6	22.5	23.5	70.5	500	0.6	FYT30K473F142FL5
300	1500	0.056	26	15.5	6	22.5	28	84	500	0.6	FYT30K563F142FL5
300	1500	0.068	26	16.5	7	22.5	34	102	500	0.8	FYT30K683F172FL5
300	1500	0.082	26	16.5	7	22.5	41	123	500	0.8	FYT30K823F172FL5
300	1500	0.1	26	17	8.5	22.5	50	150	500	0.8	FYT30K104F202FL5
300	1500	0.15	26	19	10	22.5	75	225	500	0.8	FYT30K154F242FL5
300	1500	0.22	26	22	12	22.5	110	330	500	0.8	FYT30K224F272FL5
300	1500	0.33	26	25	15	22.5	165	495	500	0.8	FYT30K334F362FL5
300	1500	0.1	32	18	9	27.5	40	120	400	0.8	FYT30K104G152GL5
300	1500	0.15	32	18	9	27.5	60	180	400	0.8	FYT30K154G152GL5
300	1500	0.18	32	20	11	27.5	72	216	400	0.8	FYT30K184G182GL5
300	1500	0.22	32	20	11	27.5	88	264	400	0.8	FYT30K224G182GL5
300	1500	0.27	32	22	13	27.5	108	324	400	0.8	FYT30K274G212GL5
300	1500	0.33	32	28	14	27.5	132	396	400	0.8	FYT30K334G262GL5
300	1500	0.33	32	22	13	27.5	132	396	400	0.8	FYT30M334G212GL5
300	1500	0.47	32	28	18	27.5	188	564	400	0.8	FYT30K474G332GL5
300	1500	0.56	32	33	18	27.5	224	672	400	0.8	FYT30K564G342GL5
300	1500	0.68	32	33	18	27.5	272	816	400	0.8	FYT30K684G342GL5
300	1500	0.82	32	37	22	27.5	328	984	400	0.8	FYT30K824G402GL5
300	1500	1	32	37	22	27.5	400	1200	400	0.8	FYT30K105G402GL5
300	1500	0.47	42	24	13	37.5	141	423	300	1.0	FYT30K474K112KL5
300	1500	0.68	42	28	17	37.5	204	612	300	1.0	FYT30K684K172KL5
300	1500	0.82	42	32	19	37.5	246	738	300	1.0	FYT30K824K212KL5
300	1500	1	42	40	20	37.5	300	900	300	1.0	FYT30K105K242KL5

General Technical Data

Application	Line-to-ground / Line-by-pass (Class Y2)
Dielectric	Metallized Polypropylene Film
Reference Standard	IEC 60384-14; UL 60384-14; GB/T 6346.14-2015
Climatic Category	40/110/56 IEC60068-1
Passive Flammability Class	B
Operating Temperature Range	-40°C ~ +110°C (85°C ~110°C, decreasing factor 1.35% per °C for Urms)
Protection	Solvent resistant plastic case UL94 V-0 Thermosetting resin sealing UL 94 V-0 compliant
Installation	Any position
Packaging	Packed in cardboard boxes with protection for the terminals
Storage Conditions	Storage time: ≤ 24 months from the date marked on the label package Temperature and relative humidity should be -10°C ~ +40°C and not more than 75%RH. RH ≤ 85% for 30 days randomly distributed throughout the year
RoHS Compliant	Compliant with the restricted substance requirements of Directive 2011/65/EU
Flame Retardant Grade	Flame retardant performance accords with horizontal combustion grade HB and vertical combustion grade V-0.

Construction

Metallized Film	OPP & Al/Zn
Metal Sprayed	Sn/Zn Alloy
Connection Electrode	Copper clad steel wire or Tinned copper wires
Plastic Case	Plastic Case (UL94V-0)
Filling	Epoxy Resin (UL94V-0)
Film Construction	Internal Series Connection 

Electrical Characteristics

Voltage Range	300Vac 50/60Hz
Capacitance Range	0.0047 μ F to 1.0 μ F
Capacitance Tolerance	\pm 10% or \pm 20% at +25°C
Capacitance	Measuring Frequency at 1kHz Measuring Voltage:1 \pm 0.2V
Standard Atmospheric Conditions for Static Test	Ambient temperature 15°C to 35°C (If there is any doubt on the results, the measurements shall be made at +20 +/- 5°C) Relative humidity 45% to 75% (If there is any doubt on the results, the measurements shall be made at 60% to 70 %.) Air pressure 86 kPa to 106 kPa.
Voltage Between Terminals U _{TT}	AC Voltage: U _R +1200Vac for 60 seconds or 2U _R +1200Vac for 2 seconds DC Voltage: 4000VDC for 2 seconds, charge current must be 1A maximum Withstanding (DC) voltage (cut off current 10mA), rise time 100V/S.
Voltage Between Terminals and Case U _{TC}	2200Vac, 60 seconds (at+20+/-2°C)
Dielectric Dissipation Factor Tg δ 0	\leq 2 \times 10 ⁻⁴
Dissipation Factor	0.0020 (0.2%) at 20°C, 1KHz
Insulation Resistance	R between leads, for C \leq 0.33 μ F at 100 V; 1 min > 15 000 M Ω RC between leads, for C > 0.33 μ F at 100 V; 1 min > 5000 M Ω * μ F
Hot-Spot	\leq 85°C
Life Expectancy	100 000hours (U _R , Θ hotspot=85°C)
Failure Rate	100 Fit
Max. Altitude	2000 m

Characteristics Curve

Maximum Current (I_{rms}) Vs Frequency

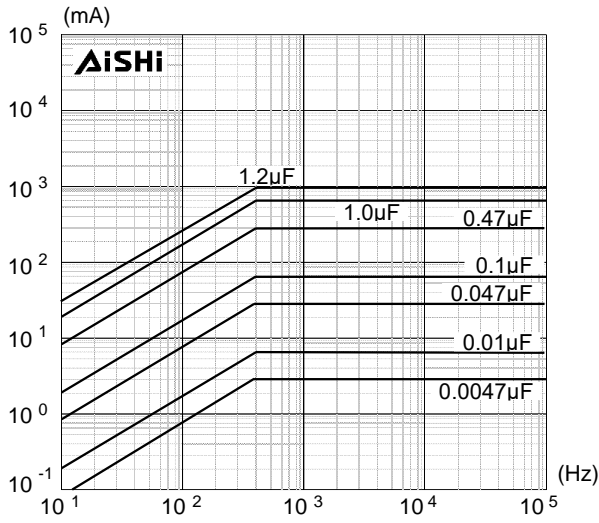

Resonant VS Capacitance

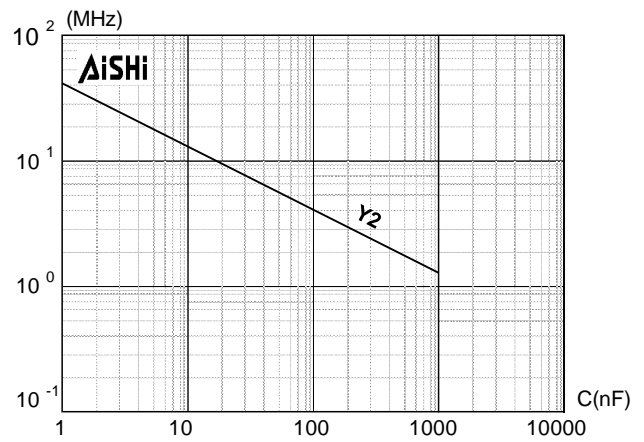

Maximum Voltage (V_{rms}) Versus Frequency

300Vac

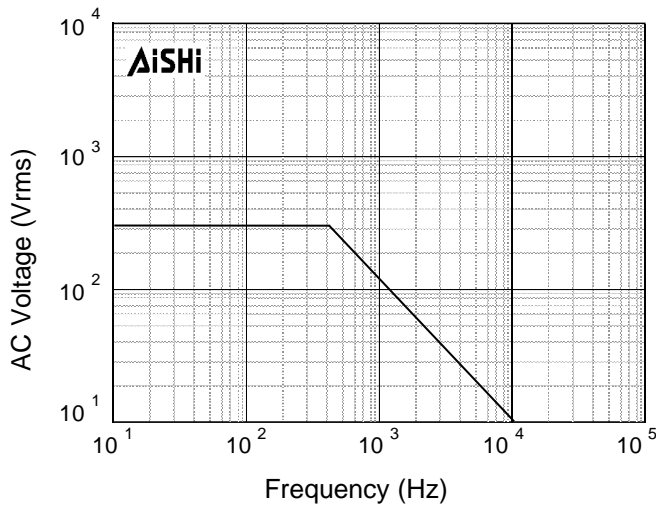

Expected Life Curve

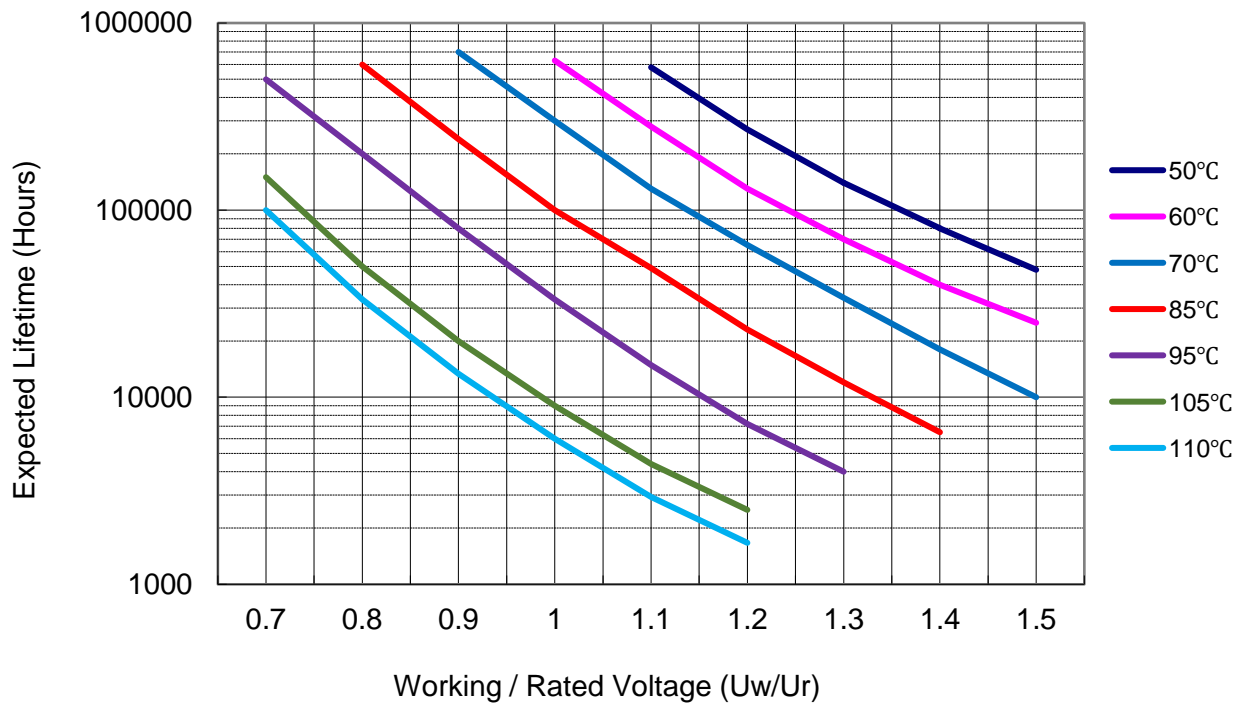

Derating of Rated Voltage Vs Temperature

(85°C ~110°C, decreasing factor 1.35% per °C for Urms)

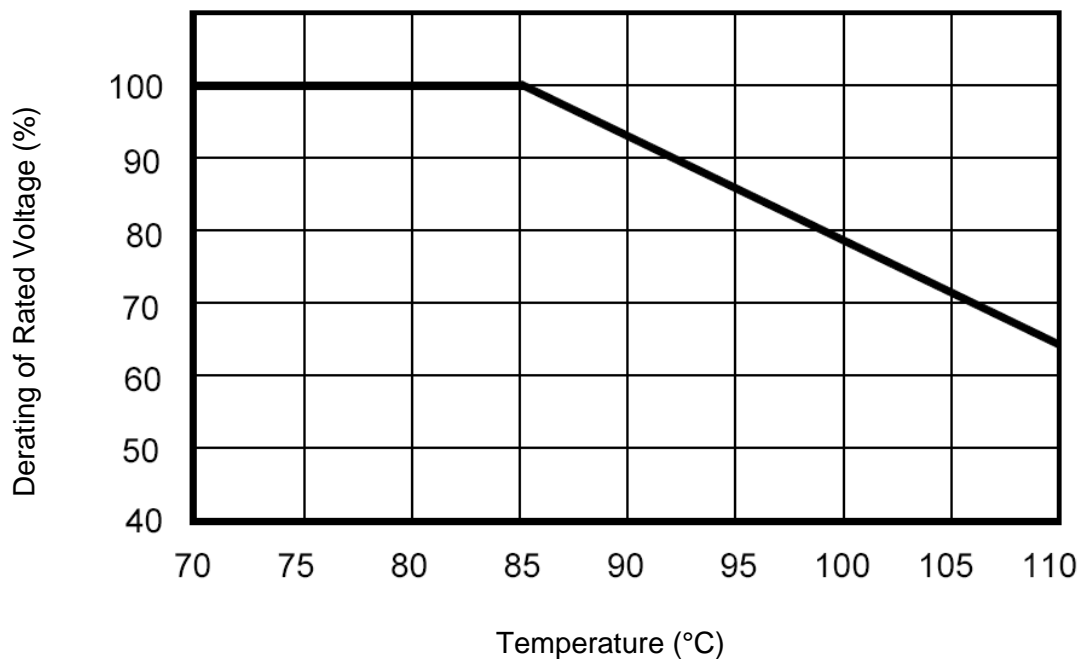

Wave Soldering Recommendations

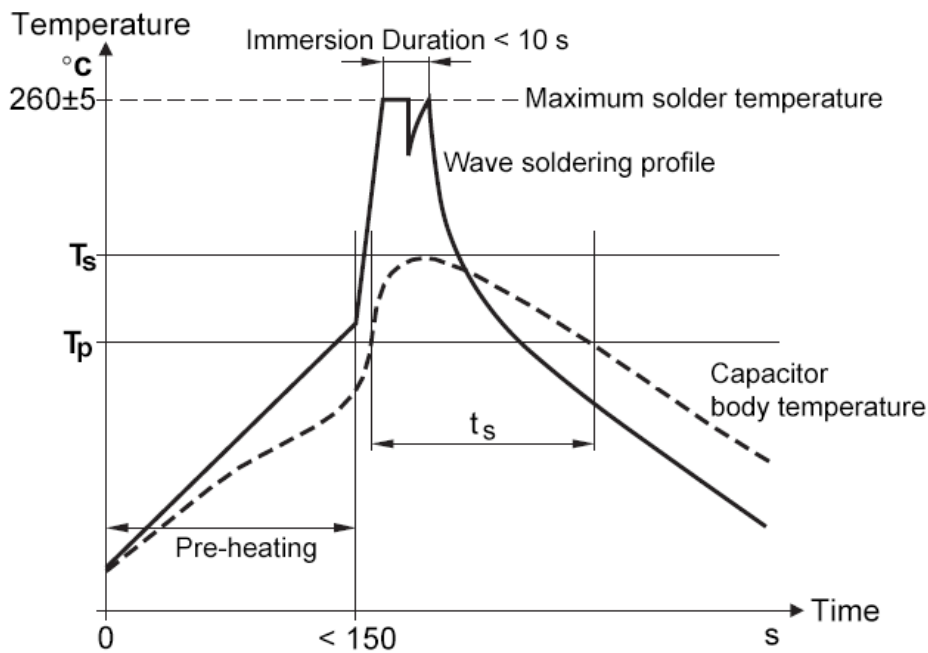

Ts: Capacitor body maximum temperature at wave soldering
 Tp: Capacitor body maximum temperature at pre-heating

Polypropylene Capacitors	Polyester Capacitors
During pre-heating: $T_p \leq 110^\circ\text{C}$ During soldering: $T_s \leq 120^\circ\text{C}$, $t_s \leq 60$	During pre-heating: $T_p \leq 130^\circ\text{C}$ During soldering: $T_s \leq 160^\circ\text{C}$, $t_s \leq 60\text{s}$

Packaging Information

Inner Box Specifications (Dimensions)			
Box #	L ±3mm	W±3mm	H ±3mm
# 1	331	331	25
# 2	331	331	35
# 3	331	331	50
# 4	331	331	80
# 5	350	170	35
# 6	350	170	50
# 7	350	170	80

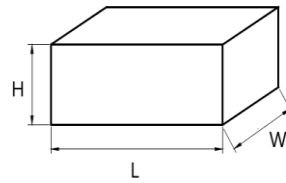

Outer Box Specifications (Dimensions)			
Box #	L ±5mm	W±5mm	H ±5mm
# 1	350	340	265
# 2	370	360	350

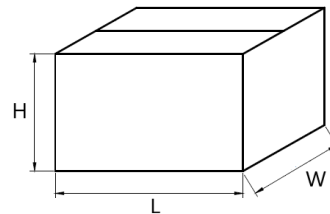

Packaging Quantity

Pitch	Size Code	Dimension			Packaging Quantity		
		W	H	T	Long Leads	Short Leads	Ammo Pack
10.0	C13	13	11	5	1,200	1,488	680
	C16	13	12	6	1,200	1,224	560
15.0	E14	18	11	5	800	1,054	680
	E17	18	12	6	800	867	560
	E29	18	13.5	7.5	800	697	450
	E34	18	14.5	8.5	600	612	390
	E47	18	19	11	600	476	300
22.5	F14	26	15.5	6	612	612	350
	F17	26	16.5	7	528	528	300
	F20	26	17	8.5	432	432	250
	F24	26	19	10	372	372	210
	F27	26	22	12	300	300	170
	F36	26	25	15	240	240	140
27.5	G15	32	18	9	340	340	
	G18	32	20	11	280	280	
	G21	32	22	13	230	230	
	G26	32	28	14	220	220	
	G33	32	28	18	170	170	
	G34	32	33	18	170	170	
	G40	32	37	22	140	140	
37.5	K21	42	32	19	112	112	
	K11	42	24	13	161	161	
	K17	42	28	17	126	126	
	K24	42	40	20	105	105	

Lead Taping Information

Taping Style: Straight leads

Lead spacing: 10 - 15mm

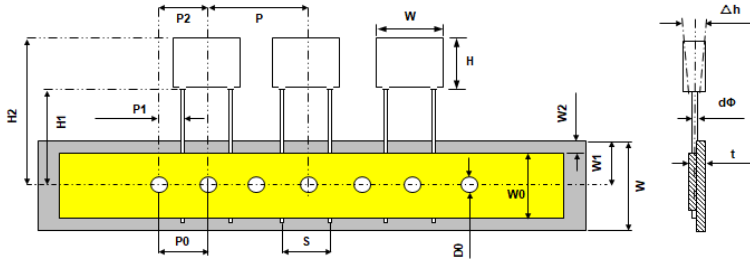

Quantity: 10pcs / line

Lead spacing: 22.5mm

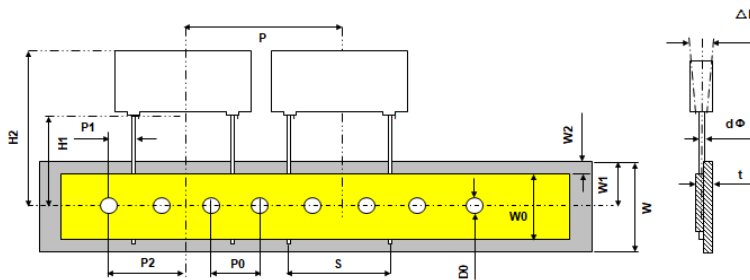

Quantity: 6pcs / line

Taping Specification

Description	Symbol	Dimension (mm)				Tolerance
Lead Spacing	S	10.0	12.5	15.0	22.5	+0.8/-0.2
Taping Pitch	P	25.4	25.4	25.4	38.0	±1.0
Feed Hole Pitch	P0	12.7	12.7	12.7	12.7	±0.2
Centering of Lead Wire	P1	7.7	6.5	5.2	7.80	±0.7
Centering of Body	P2	12.7	12.7	12.7	19.1	±1.3
Carrier Tape Width	W	18.0	18.0	18.0	18.0	±0.5
Hold Down Tape Width	W0	9.5	9.5	9.5	9.5	minimum
Hole Position	W1	9.0	9.0	9.0	9.0	±0.5
Hold Down Tape Position	W2	3.0	3.0	3.0	3.0	maximum
Feed Hole Diameter	D0	4.0	4.0	4.0	4.0	±0.2
Height of Component From Tape Center	H1	20.0	20.0	20.0	20.0	±0.5
Top Edge of Component	H2	39.0	39.0	39.0	44.0	maximum
Lead Wire Diameter	d	0.6	0.8	0.8	0.8	±0.1
Component Alignment	Δh	0.0	0.0	0.0	0.0	±2.0
Tape Thickness	t	0.7	0.7	0.7	0.7	±0.2

Cautions and Warnings

- Don't exceed the upper category temperature.
- For longtime storage, maximum relative humidity 80%, no dew allowed on the capacitor.
- Do not use or store capacitor in corrosive atmosphere, in the dusty environment's regular maintenance and cleaning especially of the terminals is required to avoid conductive path between terminal / or terminal and ground.
- Don't apply any mechanical stress to the capacitor terminals, and avoid any compressive, tensile or flexural stress.
- Don't move the capacitor after fixed to the PC board, and don't pick up the PC board by the fixed capacitor.
- Don't place the capacitor on a PC board whose holes space differs from the specified space.
- Avoid overload of the capacitors
- Do not have unlimited service life expectancy, the max service life expectancy may vary depending on the application the capacitor is used in.

Disclaimer

All product, product specifications and data in this datasheet are subject to change without notice to improve reliability, function or design or otherwise. The customer is responsible for checking and verifying the extent to which the Information contained in this publication is applicable to an order at the time the order is placed. All Information given herein is believed to be accurate and reliable, but it is presented without guarantee, warranty, or responsibility of any kind, expressed or implied.

In individual cases, a malfunction of electronic components or failure before the end of their usual service life cannot be completely ruled out in the current state of the art, even if they are operated as specified. In customer application requiring a very high level of operational safety and especially in customer applications in which the malfunction or failure of an electronic component could endanger human life or health (e.g. in accident prevention or lifesaving systems), it must therefore be ensured by means of suitable design of the customer application or other action taken by the customer (e.g. installation of protective circuitry or redundancy) that no injury or damage is sustained by third parties in the event of malfunction or failure of an electronic component.

We continue efforts to improve our products. Therefore, the products described in this publication may change from time to time. The same is true of the corresponding product specifications. Please check therefore to what extent product descriptions and specifications contained in this publication are still applicable before or when you place an order. We also reserve the right to discontinue production and delivery of products. Consequently, we cannot guarantee that all products named in this publication will always be available.

No license, express or implied, by estoppel or otherwise, to any intellectual property rights is granted by this document or by any conduct of Aishi. Product names and markings noted herein may be trademarks of their respective owners.